

HUGO GERNSBACK, Editor

RADIO CRAFT

ELECTRONIC
GUNSIGHT
FOR THE B-29
SEE PAGE 342

RADIO-ELECTRONICS IN ALL ITS PHASES

MARCH

1945

25¢

CANADA 30¢

"Meet Your Navy"

Now Carries the RAYTHEON Name
Into 3,500,000 Radio Homes Each Week!!

Free!

Ask your Raytheon distributor for colorful, attention-getting "Meet Your Navy" display to tie in with this great program. Easel-mounted, 17 1/2 inches x 20 1/2 inches.



All Four Raytheon Divisions
Have Been Awarded Army-
Navy "E" with Two Stars

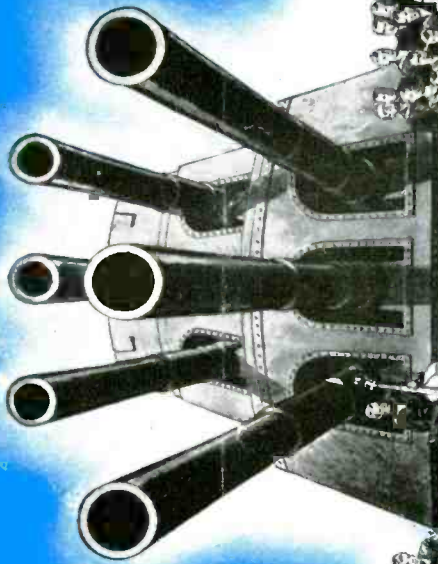

Every Saturday Night

ENTIRE BLUE NETWORK

Coast to Coast—181 Stations

RAYTHEON[®] MANUFACTURING
COMPANY

Waltham and Newton, Massachusetts

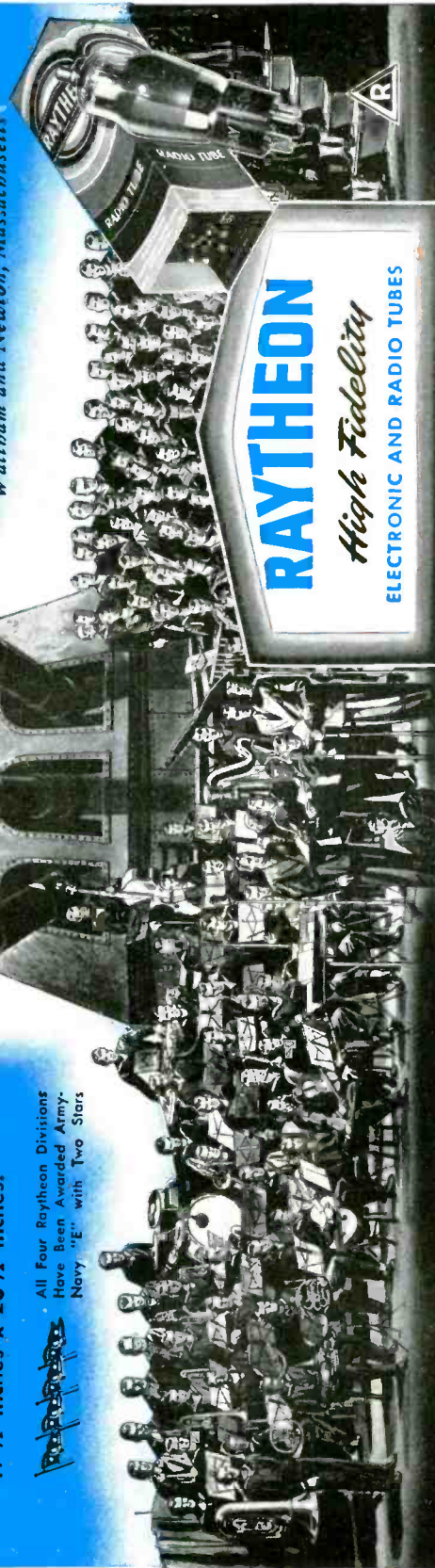

DEVOTED TO RESEARCH AND THE MANUFACTURE OF TUBES AND EQUIPMENT FOR THE NEW ERA OF ELECTRONICS

Pfc John Malik RC2-45
 Platoon B 387th E.A.Bn.
 Camp Carson, Colo.
 Code No. RC2-45

Meet the Men

WHO USE YOUR BATTERIES!



The Navy and Merchant Marine send rapid ship-to-ship messages by battery-powered flasher signal lights when radio communication might give a ship's position to the enemy.



It's difficult to locate men drifting in the sea! Water-tight battery lights on buoyant lifesaver suits have meant the difference between life and death for many Merchant seamen.



For emergency communication by voice, the Merchant Marine uses a portable megaphone to broadcast orders and instructions. Dry batteries give necessary power to the megaphone.



Two men and a bazooka make a winning team! But it takes large quantities of ammunition and dry battery power to keep these portable, hard-hitting weapons firing at the enemy.



Deadly flamethrowers are blazing the road to Victory! Dry batteries help to create the spark that sends these efficient weapons into instant, flaming action against the enemy.



The Signal Corps man with a Walkie-Talkie has freedom of speech as long as he has plenty of dry batteries! Handie-Talkies also use thousands of war batteries to power vital communications.



When they come Home — Burgess Batteries will be back again, too... powering flashlights, telephones, radios, instruments and controls for millions of homes, farms and industries throughout America.

BURGESS BATTERIES

IN THE NATION'S SERVICE

BURGESS BATTERY COMPANY, FREEPORT, ILLINOIS



REMEMBER NATIONAL UNION SERVICE DEALER ADVERTISING



AFTER THE WAR MORE THAN BEFORE

OF COURSE, you remember the cooperative advertising plans that National Union offered you before the war. Radio service dealers all over the country built up their business at minimum cost, using this powerful N. U. plan. They obtained free electros, mats and copy for telephone book and newspaper advertisements—a handsome four-color metal highway display at very low rental—a generous advertising allowance. National Union gave

radio service dealers all this in *addition* to the plan that equipped their shops with 60,000 pieces of fine test equipment *free!*

After Victory, look for more and better N. U. cooperative advertising to back you up. *Count* on N. U. to bring you more business—more profits—**MORE** than before.

NATIONAL UNION RADIO CORPORATION, NEWARK 2, N.J.
Factories: Newark and Maplewood, N. J., Lansdale and Robesonia, Pa.



NATIONAL UNION RADIO AND ELECTRONIC TUBES

Transmitting, Cathode Ray, Receiving, Special Purpose Tubes • Condensers • Volume Controls • Photo Electric Cells • Panel Lamps • Flashlight Bulbs



J. E. SMITH, President
National Radio Institute
Our 31st Year of Training Men
for Success in Radio

I WILL SEND A SAMPLE LESSON FREE to PROVE I can Train You at Home in Spare Time to BE A RADIO TECHNICIAN

I Trained These Men



**\$35 to \$45 a Week
In Own Shop**
"Previous to enrolling for your radio training I made \$12 per week in a hardware store. Now I operate my own repair shop, and often clear \$35 to \$45 a week." — **FREDERICK BELL**, 76 Golf Ave., St. Johns, Newfoundland.

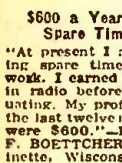

**\$600 a Year in
Spare Time**
"At present I am doing spare time radio work. I earned money in radio before graduating. My profits for the last twelve months were \$600." — **ERWIN F. BOETTCHER**, Marinette, Wisconsin.



**Chief Engineer
in Radio Station**
"When I signed up with N.R.I., I had no other Radio experience. I am now Chief Engineer for Station WJBG, and have supervised installation of new modern broadcasting studios and equipment." — **JOHN E. HENNINGER**, 4744 Meridian Street, Philadelphia, Penna.



**Gets Good Job
in Civil Service**
"Since completing your course, I have taken a job with Civil Service as a Radio Mechanic. My work is of confidential nature, but I can tell you the salary is good." — **WALTER R. PRATT**, 416 Margaret Street, Key West, Fla.



You May Never See a Better Time to Make Your Start in Radio

I will send you my Lesson, "Getting Acquainted with Receiver Servicing," FREE, to show you how practical it is to train for Radio at home in spare time. It's a valuable Lesson. Study it—keep it—use it—without obligation! And with this Lesson I'll send my 64-page, illustrated book, "Win Rich Rewards in Radio" FREE. It describes many fascinating jobs Radio offers, tells how N.R.I. gives you Radio experience by practicing with **SIX BIG KITS OF RADIO PARTS** I supply!

Future Looks Bright for Capable Radio Technicians and Operators

Many opportunities are ahead for well-trained Radio Technicians, Operators. Keeping old Radios working is booming the Radio repair business. Profits are large—Peacetime prospects are bright, too. Think of the new boom in Radio Sales and Servicing that's coming—when new Radios are again available—when Frequency Modulation and Electronics can be promoted—when Television moves into its new era of expansion!

Broadcasting Stations, Aviation Radio, Police Radio, Loudspeaker Systems, Radio Manufacturing all employ qualified Radio men at good pay—and most of these fields have a big backlog of business that built up during the war, plus opportunities to expand into new fields opened by wartime developments. You may never again see a time when it will be so easy to get a start in Radio!

Many Beginners Soon Make \$5, \$10 a week EXTRA in Spare Time

The day you enroll for my Course I start sending you **EXTRA MONEY JOB SHEETS** that help show how to make **EXTRA** money fixing Radios in spare time while still learning. I send you **SIX** big kits of Radio parts as part of my Course. You **LEARN** Radio fundamentals from my illustrated, easy-to-grasp lessons—**PRACTICE** what you learn by building real Radio Circuits—and **USE** your knowledge to make **EXTRA** money!

Mail Coupon for FREE Lesson and Book

These are fast-moving times. The opportunities now given beginners to get started in Radio may never be repeated. So take the first step at once. Get my sample Lesson and 64-page illustrated book FREE. No obligation—no salesman will call. Just mail Coupon in an envelope or pasted on a penny postal. **J. E. Smith, President, Dept. 5CX, National Radio Institute, Pioneer Home Study Radio School, Washington 9, D. C.**

You Build These and Many Other Radio Circuits with 6 Kits of Parts I Supply

By the time you've conducted 60 sets of Experiments with Radio Parts I supply, made hundreds of measurements and adjustments, you'll have had **PRACTICAL** Radio experience valuable for a good full or part-time Radio job!

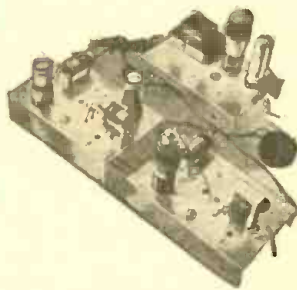

You build the **SUPERHETERODYNE CIRCUIT** (left) containing a preselector oscillator-mixer-first detector, i.f. stage, diode detector-a.v.c. stage and audiotape. It will bring in local and distant stations. Get the thrill of learning at home evenings in spare time while you put the set through fascinating tests!

You build **MEASURING INSTRUMENT** (right) early in Course, useful for Radio work to pick up **EXTRA** spare time money. It is a vacuum tube multimeter, measures A.C., D.C., R.F. volts, D.C. currents, resistance, receiver output.

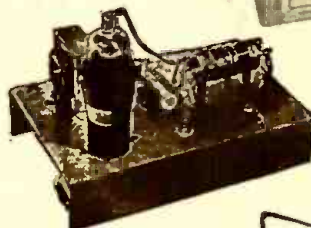
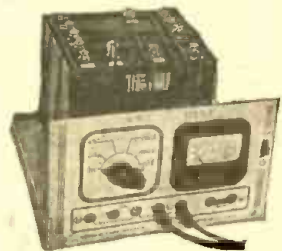

Building the **A.M. SIGNAL GENERATOR** at left will give you valuable experience. Provides amplitude-modulated signals for test and experimental purposes.

SAMPLE LESSON FREE

Mail coupon for your FREE copy of Lesson, "Getting Acquainted With Receiver Servicing," to see how practical it is to train for Radio at home in spare time. Study it—keep it—use it—without obligation! Tells how Superheterodyne Circuits work, gives hints on Receiver Servicing, Locating Defects, Repair of Loudspeaker, I.F. Transformer, Gang Tuning Condenser, etc. 31 illustrations.

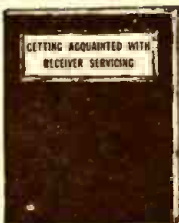

**My Radio Course Includes
TELEVISION • ELECTRONICS
FREQUENCY MODULATION**

GOOD FOR BOTH 64 PAGE BOOK SAMPLE LESSON FREE

**J. E. SMITH, President, Dept. 5CX
National Radio Institute, Washington 9, D. C.**

Mail me **FREE**, without obligation, Sample Lesson and 64-page book, "Win Rich Rewards in Radio." (No salesman will call. Please write plainly.)

Name Age

Address

City Zone State 4FB



RADIO CRAFT

AND POPULAR ELECTRONICS

Incorporating
SHORT WAVE CRAFT TELEVISION NEWS
RADIO & TELEVISION

MEMBER
AUDIT BUREAU OF CIRCULATIONS

HUGO GERNSBACK, *Editor-in-Chief*
FRED SHUNAMAN, *Associate Editor*
I. QUEEN, *Editorial Associate*
ELMER FULLER, *Shortwave Editor*
A. PASCALE, *Production Manager*
G. ALIQUO, *Circulation Manager*
JOHN J. LAMSON, *Advertising Director*
ALFRED STERN, *Promotion Manager*

IN THE NEXT ISSUE

A High-Frequency Radio Range
Radar, Bats and Supersonics
Repair of Electrical Clocks
Designing Voltage Dividers

Published by Radcraft Publications, Inc.

Publication Office: 29 Worthington Street,
Springfield 3, Mass.

Editorial and Advertising Offices: 25 West
Broadway, Tel. RE2-9690, New York 7, N. Y.

Chicago Advertising Office: Radio-Craft, 520
North Michigan Avenue, Tel. Superior 7306,
Chicago 11, Ill.

New England Advertising Office: 411 Lafay-
ette Street, Salem, Mass. Claude C. Smith,
Manager.

Cleveland Advertising Office: 405 Erie Bldg.,
Cleveland, Ohio. Burdette Phillips, Manager.
Tel. Main 9645.

RADIO-CRAFT is published monthly on the
25th of the month preceding that of date;
subscription price is \$2.50 per year in U. S.
(In foreign countries, 75c additional per year
to cover postage; Canada, 50c additional.)
Special rates for members of the Armed Forces
in U. S., or those addressed by A.P.O. or F.P.O.
mail, \$2.00. Entered at the post office at
Springfield as second-class matter under the
Act of March 3, 1879. All communications
about subscriptions should be addressed to:
Circulation Manager, Radio-Craft, 29 Worth-
ington St., Springfield 3, Mass.

Notice of CHANGE of ADDRESS should
reach us at least one month in advance. When
ordering a change, please furnish an address
stencil impression from a recent wrapper if
you can. Address changes cannot be made
without the old address as well as the new.

Foreign Agents

London—Atlas Publishing and Distributing
Co., Ltd., 18 Bride Lane, Fleet St., London,
E.C. 4.

Melbourne—McGill's Agency, 179 Elizabeth
St., Australia.

Text and illustrations of this magazine are
copyright and must not be reproduced without
permission of the copyright owners.
Copyright, 1945, Radcraft Publications, Inc.

Contents March, 1945 Volume XVI, No. 6

Editorial: "Pay or Squeal" Radios	by Hugo Gernsback	337
Radio-Electronics Monthly Review		338
Solve Navy Problems!		387

AVIATION RADIO

Electronic Flight Control	by Raymond Lewis	340
B-29 Electronic Gunsight		342
Plane Temperature Electron Control	by R. H. Whempner	352
Auto Compass Aids Bombing		370

ELECTRONICS

Votes by Radio	by T. R. Kennedy	343
A Heat-Variable Resistor		353
Two Compact Sets	by G. L. Keirstad	355
Radio Jockey	by Eric Leslie	358
Sensitive Alarm System		371
Postwar Radio Newsprinter		372

RADIO TRAINING

Grounded-Grid Amplifiers	by Stuart T. Black	349
Broadcast Equipment, Part VII	by Don C. Höffler	346
Speech Amplifiers, Part VI	by Robert F. Scott	354

SOUND

Recording on Wire	by I. Queen	345
High Fidelity	by McMurdo Silver	347
Intercommunicators	by M. N. Beitman	350
Phonograph "Buzz" Cure		359

SERVICING

Meter Adaption	by Alfred Shortcut	344
Circuit Equalization	by Robert Smith	348
Radio Headphone Circuits	by John Kearney	356

CONSTRUCTION

A Seven-tube Super	by Edwin Bohr	351
New Idea in Detector Circuits	by W. T. Connatser	356
Two Compact Sets	by G. L. Keirstad	355

DEPARTMENTS

World-Wide Station List	by Elmer R. Fuller	357
New Radio-Electronic Devices		360
Radio-Electronic Circuits		362
Try This One!		364
Question Box		366
Progress in Invention	by I. Queen	374
Available Radio-Electronic Literature		376
Technotes		383
The Mail Bag		386



ON THE COVER

The electronic sighting device on our cover this month is one of the reasons for the B-29's efficiency. Permitting any of five gunners to operate three turrets at once, it has the effect of practically tripling the great plane's fire power.

5 YEARS AHEAD OF ITS TIME

FM
AM
CW



27.8 to 143 Mc

Covers old and new FM bands

hallicrafters Model S-36

EXACTLY five years ago—in 1940—Hallicrafters introduced a very high frequency communications receiver with a range of 27.8 to 143 Mc. This model was clearly five years ahead of its time in its anticipation of new and exciting possibilities for superior performance on the higher frequencies. Today Model S-36 stands by itself as the only commercially built receiver covering this range. It is outstanding for sensitivity, stability, high fidelity. With its extraordinary VHF versatility it is ready for immediate application in the ever widening fields of FM and higher frequency development work. Engineering imagination at Hallicrafters is reaching out beyond the next five years, beyond the present known limits of radio technique so that Hallicrafters equipment will continue to be always ahead of its time, above and beyond your best expectations.



BUY A WAR BOND TODAY!

hallicrafters RADIO

THE HALLICRAFTERS COMPANY, MANUFACTURERS OF RADIO AND ELECTRONIC EQUIPMENT, CHICAGO 16, U. S. A.

ALDEN

for Graphic Recording of any kind

OUR YEARS OF EXPERIENCE, and cumulative skills, in the designing and production of RADIO COMPONENTS, are now being used in making equipment which covers the entire field of **FACSIMILE**.

Actual service, as found in war and communication work under all conditions, has given a **PRACTICAL** quality to our equipment which, under ordinary conditions, would not have been obtained in years of engineering with limited application.

ALDEN PRODUCTS COMPANY is manufacturing practically ALL TYPES AND SIZES of facsimile and impulse recording equipment—using all the varied recording mediums: Photographic Paper, Film, Electrolytic Paper, Teledeltos, and Ink.

ALFAX IMPULSE RECORDING PAPER

By "COVERING THE ENTIRE FIELD," we mean

1. Some of our equipment has been used for the transmitting and receiving of photographic pictures of reasonably high resolution (such as the war pictures now appearing in the news).
2. Continuous Recorders—of the type whose value has been proven on National and International news service circuits—are now on their way to the Orient, to be used for the receiving of the so-called "picture" languages. They use ALFAX paper.
3. Also, through the use of ALFAX (the first high-speed black and white permanent recording paper), HIGH-SPEED Signal Analysis Equipment has been made possible for various laboratories and Government Departments. Other equipments have employed Teledeltos Paper for message work and other purposes.
4. For outlying posts, where servicing equipment is an impossibility, or where radio or wire links are of poor quality and power, ALDEN Tape Recorders (recording medium, ink)—have been designed to operate with a minimum of trouble and adjustments, and have **PROVED MOST SATISFACTORY**.
5. The ability of ALFAX Paper and ALDEN Machines to record impulses **AS THEY OCCUR**, without the inertia problems of many previous methods, has made possible other recorders at various speeds (including slow). They will record a whole day's history of related phenomena, with time indicated, and often—with self-calibrated linear reference marks for ready interpretation.

ALDEN PRODUCTS COMPANY

117 North Main Street

BROCKTON (64J), MASSACHUSETTS

.....

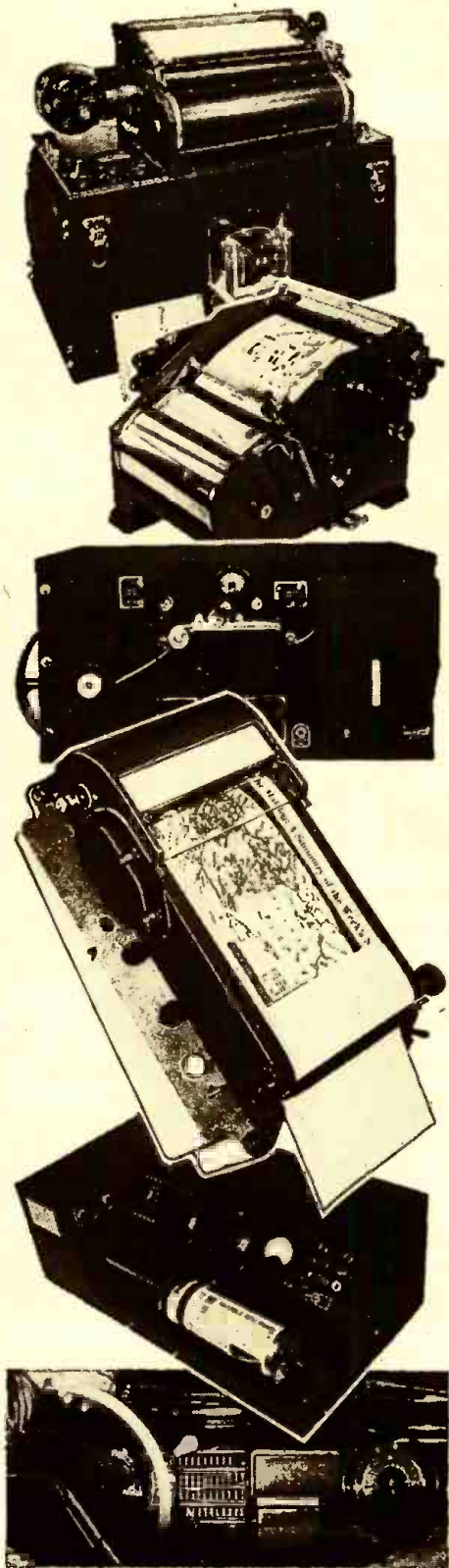

Here is the one quick practical way to

REALLY LEARN RADIO • ELECTRONICS and TELEVISION



**..YOU GET
A COMPLETE
RADIO SET**

SPRAYBERRY RADIO TRAINING

Gives you Both



BE A TRAINED TECHNICIAN

There's only one *right* way to learn Radio Electronics. You must get it through simplified lesson study combined with actual "shop" practice under the personal guidance of a qualified Radio Teacher. It's exactly this way that Sprayberry trains you . . . supplying real Radio parts for learn-by-doing experience right at home. Thus, you learn faster, your understanding is clear-cut, you acquire the practical "know how" essential to a good-paying Radio job or a Radio business of your own.

A Bright Future

Now's the right time to start training. Because Radio is surging forward, expanding at a rapid pace . . . with the promise of spectacular opportunities in Television, Frequency Modulation, Industrial Electronics . . . in the vast Radio Service and Repair business. When you train with Sprayberry, you need no previous experience. The Course starts right at the beginning of Radio, even shows you how to make spare time profits while learning.

I'll Show You a New, Fast Way to Test Radio Sets without Mfg. Equipment

The very same Radio parts I supply with your Course for gaining pre-experience in Radio work may be adapted through an exclusive Sprayberry wiring procedure to serve for complete, fast, accurate Radio Receiver trouble-shooting. Thus, you do not have one cent of outlay for manufactured Test Equipment, which is not only expensive but scarce. In every respect, my training is practical, complete . . . tested and proved for results. It will give you the broad, fundamental principles so necessary as a background, no matter which branch of Radio you wish to specialize in.

MAIL COUPON NOW !

JUST OUT! FREE! HOW TO READ RADIO DIAGRAMS AND SYMBOLS

. . . a valuable new book which explains in simple, non-technical English how to read and understand any Radio Set Diagram. Provides the quick key to analyzing any Radio circuit. Includes translations of all Radio symbols. Send for this FREE book now while supply lasts and along with it I will send you another big FREE book describing my Radio-Electronic training.



GET FREE BOOKS

SPRAYBERRY ACADEMY OF RADIO
F. L. Sprayberry, Pres.
Room 2035
Pueblo, Colorado

Please rush my FREE copies of "HOW TO MAKE MONEY IN RADIO, ELECTRONICS and TELEVISION," and "HOW TO READ RADIO DIAGRAMS and SYMBOLS."

Name Age

Address

City State

Tear off this coupon, mail in envelope or paste on penny postcard.

SYLVANIA NEWS

RADIO SERVICE EDITION

MARCH

Published in the Interests of Better Sight and Sound

1945

**SYLVANIA
SERVICEMAN
SERVICE**

by
FRANK FAX



Among the newest of Sylvania Electric's helps for servicemen is a large chart, measuring about 32 by 43 inches, and lithographed in 4 colors, showing in full detail the parts and assembly of a Sylvania Lock-In Radio Receiving Tube. The chart,

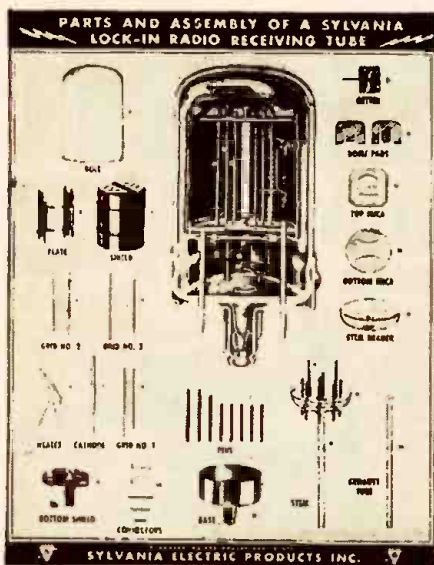

which is reproduced in the accompanying illustration, clearly shows the location of each part in the complete assembly of the tube.

This chart is being distributed to servicemen throughout the country, and is free on request to Emporium, Pa.

Sylvania Launches Broad Study of Public's Wants in Sets and Tubes

Servicemen's Problems to Get Special Consideration in Nationwide Survey

As a major step in its consistent policy of assisting radio servicemen to carry on their business efficiently and profitably, Sylvania Electric Products Inc. is launching a nationwide survey of the trends of public preferences and buying habits in the field of radio and television sets and tubes. The

information is expected to be of great value to servicemen in planning for postwar.

Thousands of personal interviews will

SYLVESTER SURVEY

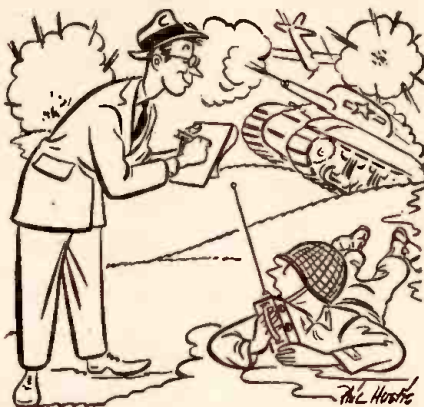

"I wonder if I could have your views on what the postwar radio will be like?"

HANDY UNIT LIGHTS HARD-TO-REACH SPOTS



The Sylvania Fluorescent Extension Cord Lamp, which fits through openings as small as 2 inches square, brings the advantages of fluorescent lighting to hard-to-reach spots, and may prove a useful tool for the serviceman.



Here is the first of the new Sylvania questionnaire advertisements.

be conducted with set owners, to determine the types of new sets they plan to buy, and also to study the market for postwar renovation of old sets and for tube replacements. In addition, Sylvania Electric is initiating a series of questionnaire advertisements, which will reach millions of readers of national and general business magazines.

These advertisements will stimulate public interest in getting the most out of radio and television, and hence will help to build business for the serviceman. Results of the survey will be published in future issues of SYLVANIA NEWS.



SYLVANIA ELECTRIC

SYLVANIA ELECTRIC PRODUCTS INC., Radio Division, Emporium, Pa.

MAKERS OF RADIO TUBES; CATHODE RAY TUBES; ELECTRONIC DEVICES; FLUORESCENT LAMPS, FIXTURES, ACCESSORIES; INCANDESCENT LAMPS

To Help You Learn **RADIO** **ELECTRONICS** Faster·Easier

PRACTICAL EQUIPMENT

HOME MOVIES

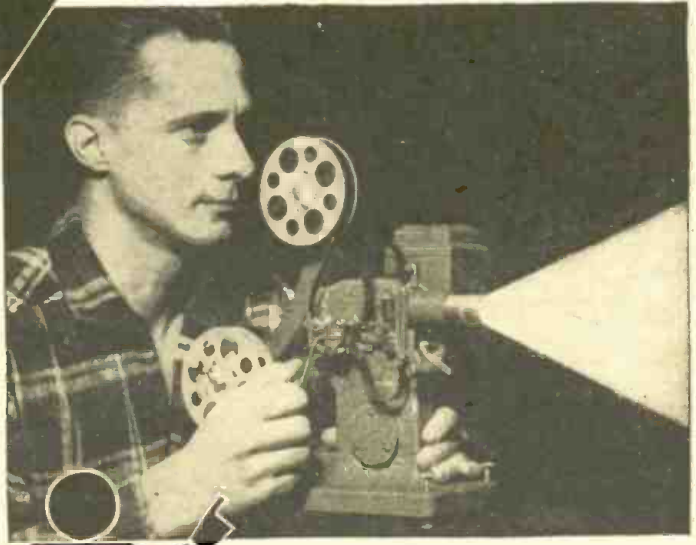

Make 133 Fascinating Experiments In Spare Time At Home

THINK OF IT—real radio parts and sub-assemblies—EIGHT BIG KITS of them—enough genuine parts to assemble not one but SIX Radio Receiving Circuits that work. You build a SUPER-HET, a SHORT-WAVE, a LONG-WAVE Aviation Band Circuit, a LIGHT BEAM TRANSMITTER, a WIRELESS MICROPHONE, ELECTRIC EYE devices, a RADIO TELEPHONE and scores of other fascinating projects. DeForest's unique "Block System" speeds building of new circuits—gives you valuable "Learn-By-Doing" experience at home—helps you prepare effectively for today's many grand Radio-Electronic opportunities. Get the complete facts! Mail coupon today for big, free book "VICTORY FOR YOU." You also get the colorful KIT FOLDER that tells about some of the many exciting experiments you build from DeForest's "Home Laboratory."

GET INTO RADIO AND ELECTRONICS

See how you may prepare in your spare time at your home—and without interfering with your present position—to get into the vast, Billion Dollar Radio field that needs so many trained men TODAY, and that promises many exciting postwar opportunities. Find out about the opportunities ahead of F. M. Radio, Two-Way Train Radio, Radio Manufacturing, Police Radio, Broadcast Radio, Motion Picture Sound—about the postwar possibilities of Television—about the opportunity to be your own boss in your own Radio Business.

GET FACTS ABOUT THIS MODERN FIELD

... that offers so many real money-making opportunities for the trained man who is on his toes. Mail the coupon Now—TODAY. Do this! Find out about this NEWER... BRIGHTER future facing you in the grand field of Radio and Electronics. See how DeForest's helps you make your start by means of its effective "A-B-C" Training method.

YOU GET EMPLOYMENT SERVICE

DeForest's also provides its students and graduates with an effective EMPLOYMENT SERVICE that has long-established contacts with employers who use many DeForest's trained men. Mail the coupon today!

VETERANS: Check coupon at right for Special Information

You Use Both
with DeFOREST'S

Plus

"Learn-By-Seeing" Movies—Add Life to Lesson Texts

YOU GET MOVIES—exciting training films which you project in your own home! How much more INTERESTING it is to grasp important fundamentals when right on the wall of your room you are able to see RADIO waves in motion... circuits come to life... Electrons on the march. Thanks to the use of a genuine DEVRY movie projector and 12 reels of exclusive training films, you see Radio-Electronic actions otherwise hidden from the eye. Think how much it will help you, to actually see IN MOTION the principles of what you are learning. DeForest's modern training, alone, provides this valuable aid to learning Radio-Electronics at home.

90 LOOSE-LEAF LESSONS

Where else can you get such a combination of proved major training features as—(A) 90 modern, well-illustrated loose-leaf lessons prepared under the supervision of Dr. Lee DeForest, often called the "Father of Radio"; (B) the use of "Learn-by-Seeing" home movie training films and a genuine DEVRY movie projector; and (C) the use of many practical Radio parts? You be the judge. No obligation.



DeForest's Training Offers Instruction in Motion Picture Sound Equipment, FM Radio and Television



DeFOREST'S TRAINING, INC.
CHICAGO 14, ILLINOIS

E. B. DEVRY, President,
DeForest's Training, Inc., Dept. RC-33
2535-41 N. Ashland Ave., Chicago 14, Illinois

Please send me—FREE and WITHOUT OBLIGATION—illustrated book, "VICTORY FOR YOU," and Kit Folder.

Name.....Age.....

Address.....

City.....State.....

- If under 16, check here for special information.
- If a veteran of World War II check here.

SPRAGUE TRADING POST

A FREE Buy-Exchange-Sell Service for Radio Men



THREE STAR PERFORMANCE!

Note that the Sprague Army-Navy E Flag now contains three stars. These stars, coupled with the original flag presentation means FOUR separate citations for outstanding service in supplying Sprague Capacitors and Koolohm Resistors to match the exacting demands of the nation's armed forces.

Such a fact explains better than words why it has sometimes been impossible to meet all civilian needs for these products. But it also shows beyond question of doubt that, whenever you can obtain them, you can rely on Sprague Capacitors and Koolohm Resistors for the utmost in service and dependability!

Ask for them by name. We'll appreciate it!

FOR SALE—Confidence tube checker, 2 meters, portable, A-1 condition, \$25; Ditto later type, uses 0-1 mil. 3 inch meter, 2-scales, \$35; Dayrad 381 tube tester, 4 inch tube, meter 2 1/2-inch AC meter, bench type, \$25; Cunningham tube tester, built-in power supply complete—3 1/2 test meter Weston 0-1—3/4-inch AC meter—short check, large bench type, 150 lbs., can be modernized, A-1 condition, \$50, Box 124, Valatie, N. Y.

WANTED—Hallcrafters S-20-R comm. receiver, Cash, Butler & Sparck, Suffolk San., Holtsville, L. I., N. Y.

WANTED—Supreme No. 529 frequency modulator; or a Jackson 420 oscillator. If I can purchase this No. 420 oscillator, will have for sale a RCA 167 oscillator, also a Triplet 1220A free point tester and No. 1200 multi-tester. Ted Hamilton, What Cheer, Iowa.

FOR SALE OR TRADE—12 inch dynamo and 8 inch PM speakers, 12 inch @ \$5, 8 inch @ \$3—or will trade for a-c volt-meter or one edition of Rider's manual. Also have for trade editions one and two of Dynamo-Electrical Machinery and other books. Ed. Johanson, R.F. 8-1, Monticello, New York.

RADIO EQUIPMENT WANTED—Will buy or trade Argoflex F4.5 camera, color adaptor, case, etc. also Remington dual electric shaver No. 708, Harry Qursch, 1481 Shakespeare, Bronx, New York 52, New York.

WANTED—Used tube tester in good condition, Cash, Vern Walker, 715 East A St., Grants Pass, Oregon.

WANTED—Oscilloscope or cathode ray tube, also any other test eqpt., parts, or recording eqpt. Kelsey Litton, 705 N.W. 35th St., Oklahoma City, Okla.

NOTICE—Please write plainly and describe your equipment accurately when sending advertisements to be run free of charge in the Sprague Trading Post. This will help simplify our job of handling hundreds of advertisements every month—and it will assure prompt, accurate presentation of what you have to sell or what you want to buy.

WANTED—Sky Buddy or Sky Champion or similar comm. receiver, William T. Kamish, 807 Park Ave., Austin, Minn.

WILL TRADE—3 1/4 x 4 1/4 plate back camera with f7.5 lens for comb. recorder and playback unit or other phono eqpt. Harold L. Parker, 9706—110 St., Richmond Hill 19, N. Y.

FOR SALE—Radio City No. 307 tube tester, \$25, R. H. Safford, 3104 Flesher St., Greentown Village, Dayton 10, Ohio.

FOR SALE—Two Audak low impedance pick-ups for 16 inch transcription records, \$5 each, Want Carron sis. tracer, Carron audio oscillator and carron r-f six. generator, Hohlfeld Elec. Co., Greenleaf, Kans.

WANTED—RF oscillator & antenna units, and IF and discriminator transformers for PM. Also want electric phonograph with crystal pick-up, but without amplifier. Louis Broadbent, 4222 No. Marmora, Chicago, Ill.

FOR SALE—Solar CC condenser tester in excellent condition, Ted Hamilton, What Cheer, Iowa.

WILL TRADE—McMurdo-Silver comm. receiver, 8-tubes, for good combination radio-phonograph, Robert Clements, Route No. 2, Howell, Mich.

WANTED—Electric driven phonograph with crystal pick-up or a good spring-wound turntable and motor with crystal pick-up. Prefer 110v 60 cycle electric drive. M. E. Nimbar, Moberidge, S. Dakota.

WANTED—Up-to-date tube tester, volt meter-ammeter and radio analyzer, or any radio test eqpt. Forrest Williams, 907 N. Illinois Ave., Litchfield, Ill.

FOR SALE—HY114B, 9002 tubes; components for 112 mc receivers and transmitters. Want two Sylvania stock boy cabinets in good condition. Fox Radio Service, 435 So. 5th St., Richmond, Ind.

WANTED—25Z5 tubes, Cash or will trade other tube types. Don Blackert, 840 N. E. 28th St., Oklahoma City 5, Okla.

FOR SALE—Western Electric 77-A telephone repeating coils (new) \$25 per pair. Goggan Radio Sales, Henderson, Texas.

URGENTLY NEEDED—World War II vet needs test eqpt. for radio service shop. Describe fully. Will pay cash. Howard Radio Service, 1120 S. Francisco Ave., Chicago 12, Ill.

IF YOU APPRECIATE the Sprague Trading Post service—and hundreds of radio men have told us that they do—we know we can count on you to ask for SPRAGUE CAPACITORS and SPRAGUE KOOLOHM RESISTORS by name, and to insist on getting them whenever they are available. They will not let you down!

WANTED—One 2 1/2 meter rig for WERS. Cash, Morton Bardfield, 4 Brinsley St., Dorchester 21, Mass.

TUBES FOR SALE—Over 700 new and used. Write for list, Mason Radio, 114 E. 3 St., Mt. Vernon, N. Y.

WANTED—1A7; 1N5; 1H5; 1A5; 50L6; 35Z5; 35L6; 12SA7; 12SQ7; 12A8; 25B8; and 70L7 tubes. State price & quantity. Ellison Radio Service, Centertown, Ky.

FOR SALE OR TRADE—One Stewart-Warner H-1781 auto radio, 6 tubes; also two General Motors 6-tube auto radios in good condition. Will trade for a combination radio-recorder player, or an amplifier. Harry Gludich, 37 Gold Court, Huntington Sta., L. I., N. Y.

FOR SALE—New 30-watt p.p. output transformer for 6L6's. Also speakers, power transformers and a limited number of tubes. Martin Johnson, Alliance, Nebr.

WANTED—12, 35, 50, and 70 volt tubes, tube tester, condenser analyzer, six. generator, VTM, and Rider's manuals. Royce Saxton's Radio Shop, R. No. 1, Pontiac, Ill.

FOR SALE—Supreme No. 555, de luxe diaphragm (3 inch scope & all-wave six. generator combined). Generator needs slight repair. Cost \$180. Will sell for \$100. G.O.B. Radio Bldg, 316 E. Clay St., Stockton, Calif.

WILL TRADE—Two new 50L6GT tubes for Charlie McCarthy cabinet (must be good). Also want Presto recorder. Keeler Radio Service, 1625 S. Keeler Ave., Chicago 23, Ill.

WILL TRADE New 1A5GT tubes, used 25-cycle Green Flyer phono motor. Want 12SA7GT, 1A7GT tubes, Rider manual No. 11, Globe Radio, 106-10 New York Ave., Jamaica, N. Y.

WANTED—Record changer, turntables, and pick-up and cutting arm, also airbrush & compressor, John H. Miskell, 1135 Maple St., Mt. Vernon, Ill.

URGENTLY NEEDED—Type 276-A or 203-A power transformer with sec. 1200v @ 200 ma.; filament transformer with sec. 10v @ 4 a. or over, both with 115v primaries; Want fixed condensers 50 mmf. @ 5000v; .002 mfd. @ 2500v; variable condensers 100 mmf.; about 10 feet tinned copper wire; 50 watt 10,000 ohm fixed resistor, and 70L7GT, 50L6GT, 95B, 1S5, and 3Q4 tubes. What have you? Ned L. Osborne, 502 Crestview Rd., Columbus 2, Ohio.

WANT—6v phono motor, 30-watt amplifier, small radios, Haro plenty of 5Y3, 80, 45, 6SD7, 6SK7, 6SQ7, 6K7, 26, 27, etc. to swap or sell. Standard Radio Service, 428 Main St., Hamilton, Ohio.

SWAP OR SELL—Want barograph, airplane instruments & gauges, notes on artificial vision, VTM, oscilloscope, modern tube checker, wide range signal generator, etc. Will pay cash or trade Miller oscillator, Philco and Supreme 85, Precision 500A electrometer tube checkers; Supreme 504 analyzer and Jewel 414 analyzer plus lots of meters & parts. What do you need? B. Hurley, Box 272, Sequel, Calif.

FOR SALE—Supreme 562 audolyzer, good condition, latest model, \$80. Triplet 1175A all-purpose tester consisting of 1125B, F-O-M, 1151A S.G., and 1186B free point tester, 4 yrs. old, \$40, Stanley Luffy, R.D. No. 1, Box 293, Verona, Pa.

FOR SALE OR SWAP—Riders No. 2 manual; 12 inch speakers PM and 5000 ohm fields; 6v generators; Parabolic, baffles; 400v-250 mil. plate trans. 250 mil swinging choke; Supreme No. 333 analyzer; Weston No. 444 analyzer. Want Riders Nos. 5, 9, 10, 13, television receiver, 5 inch cathode ray tube, frequency modulated six. generator, and Precision resistors. Henry's Radio, 410 Thomas St., Newport, Rhode Island.

URGENTLY NEEDED—Com. receiver covering from 550 kc. to 30 mc. Cash. State condition & price. Sgt. Chas. W. Snodgrass, 148 77th M.P. Bn., Communication Section, Ft. Sam Houston, Tex.

SWAP OR SELL—Want Rider's manuals Nos. 12 & 13, also one each 6A7, 12SK7, 35L6, 35Z5 tubes. Have following for trade: 60-watt and 35-watt composite built audio amplifiers; one M-20 Jensen auditorium speaker unit; several 500 ohm to V.C. transformers; one 1:1 transformer; code machine and 13 tapes, also quantity ham parts & tubes. Kenneth Law, Fairmount, Ind.

FOR SALE—Contents of radio lab: 2 inch, 3 inch, and 5 inch cathode ray tubes; metal VHF, acorns and midjet tubes; 0-1 ma., 0-200 microamp, and 0-50 microamp meters; Precision 100 kc. scale; Precision resistors & condensers; Sprague hi-voltage condensers; etc. Other parts too numerous to mention. Rufus Lee, 1123 Wagner Ave., Philadelphia 41, Pa.

TUBES FOR SALE—New in original cartons, 1 each: 11D5, 11G6, 7A4, 31, 34, 77, Two each: 1B5, 6AC5, 6SH7, 7A7, 7AY8, 12A5, 12SL7, 39/44; 3-76; 4-37, 5-7B6, W. G. Green Radio Service, 414 Pine St., Allegan, Mich.

WANTED—Urgently need tube tester, also a good signal generator, Harry J. Shroyer, 815 So. 15th St., St. Joseph 36, Mo.

FOR SALE—New Motorola auto radios for 1941-42 Buicks, 1942 Chevrolets, 1943 Fords, in factory cartons. Paul Capito, 637 W. 21 St., Erie, Pa.

FOR SALE OR SWAP—Triplet 1210A tube checker and Weston 770 tube checker. Want to get a six. generator or oscilloscope. Loewy's, 43 Pallaso Ave., Yonkers 2, N. Y.

WANTED FOR CASH—Rider's manuals No. 5 to No. 14, also late model Hickok signal generator. Clyde O. Davee, 405 University Ave., San Diego 3, Calif.

SEND US YOUR OWN AD TODAY!

For over two years now, the Sprague Trading Post has been helping radio men get the materials they need or dispose of radio materials they do not need. Literally thousands of transactions have been made through this service. Hundreds of servicemen have expressed their sincere appreciation of the help thus rendered.

Send your own ad to us today. Write PLAINLY—hold it to 40 words—or less—confine it to radio materials. If acceptable, we'll gladly run it FREE OF CHARGE in the first available issue of one of the five radio magazines wherein the Trading Post appears every month.

HARRY KALKER, Sales Manager

Dept. RC-35 SPRAGUE PRODUCTS CO., North Adams, Mass.

Jobbing Sales Organization for Sprague Electric Company



SPRAGUE CONDENSERS

KOOLOHM RESISTORS

TM. REGISTERED U. S. PATENT OFFICE

Obviously, Sprague cannot assume any responsibility, or guarantee goods, services, etc., which might be exchanged through the above advertisements.

MAKE MORE MONEY

IN
Radio TELEVISION
& ELECTRONICS

Now!

GET THESE 2 BIG BOOKS

FREE!

You men already in Radio know how great the demand is for trained, experienced servicemen, operators and technicians. You know how fast the field is growing and how important it is to keep up with developments — F.M. Receivers, Electronics and Television. You know, too, a fellow cannot learn too much about any industry for **REAL SUCCESS**. Whether you have experience or are merely **INTERESTED** in radio as an amateur, you must recognize the **WONDERFUL OPPORTUNITY** right within your grasp to cash in on your natural abilities. Make them pay dividends. Get into the **EXPERT RADIO SERVICE FIELD**. Be an F.M. and **TELEVISION specialist—OWN A BUSINESS OF YOUR OWN**, if you prefer. Fill out and mail the coupon below for all the details of our plan.

Get the Latest Inside Information—Short Cuts—Trade Secrets by

Here's Just a Few of the Interesting Facts you Learn with the **FREE MANUAL**.

1. Routine for diagnosing Radio Troubles.
2. Preliminary Inspection of Receivers.
3. How to Check Power Supply.
4. How to Identify Various Stages of Receiver.
5. How to Trace the Circuit and Prepare Skeleton Diagram.
6. How to Test and Measure Voltages.
7. How to Test Speaker in Audio Stages.
8. How to Test Detector, I.F., R.F., and Mixer Stages.
9. Complete Reference Table for Quickly Locating Receiver Troubles.



SHOP METHOD HOME TRAINING

FROM A REAL ESTABLISHED RESIDENT SCHOOL

Now the famous National Schools brings its exclusive Shop-Method of training right into your own home. You can learn the most up-to-date, approved projects, systems and circuits step by step in your spare time. This is the sound practical training you want and need—the development of experienced instructors working with thousands of students right in shops, NEW F.M. broadcast studios and experimental laboratories of **NATIONAL SCHOOLS**—one of the most advanced trade educational centers in the world.



LEARN BY DOING

Work with Real Experimental Equipment Furnished without Extra Cost as Part of Your National Training

Experience is the best teacher. You learn by experience with the exclusive National Shop-Method of Home Training. In the course of your study you actually build various types of receivers—a powerful superheterodyne, a signal generator, an audio oscillator and others—You make tests and conduct experiments that show you the *why and how of things*. You understand what makes the various elements of electronics operate because you actually see them work for you. Not only do you gain marvelous experience by this method of learning but you receive valuable equipment you will use on the job in the practice of your profession as an electronics expert. *Mail the coupon* and learn what this means to you.

National Trained Men Now Making the Best Money in History

The real value of National training shows up on the quick progress our men make on the job. Incomes that seemed fantastic only a short time ago are now being reported by National graduates. And this is only a sample of what the future holds for the **MAN WHO KNOWS RADIO, ELECTRONICS, F.M., TELEVISION** and allied subjects. National is proud of the progress its graduates are making all over the world. Read the facts—the actual proof in the books we send you **FREE**.

Send the Coupon and prove to yourself what YOU can do in **RADIO!**

Be Sure Of Your Success And Security After The War

Don't let your post-war ambitions lag. Don't let YOUR future depend on others. Build a career for yourself. Never in all history has the returning serviceman, or war worker been confronted with such a great future if he reaches out and grasps it **NOW**. Here is a new world opening before you. Get ready now while you are still in uniform—while you are on your war job. Then you can soon step into an essential, well paid position or, with little capital, **GET INTO BUSINESS FOR YOURSELF**. It isn't a bit too soon to start now. Radio men are vitally needed. Fill out and mail the coupon immediately and examine the **NATIONAL SHOP METHOD HOME TRAINING COURSE** carefully, without obligation.

FREE LESSON INCLUDED

Examine the exclusive National Shop Method of Home Training. See for yourself how sound and practical it is. Be convinced that you can learn Radio, Electronics, Television—quickly and easily in your spare time. You can't tell until you try. This trial is **ABSOLUTELY FREE**. Fill out the coupon immediately while you are thinking about it and drop it in the mail at once.

Mail the coupon here for the books that tell you the complete story of the marvelous new system of training in Radio, Electronics and Television. Learn the facts of this exclusive shop-method of home training. See for yourself! **DECIDE FOR YOURSELF!**

This is the **MODERN SYSTEM OF TRAINING**: it matches the rapid progress constantly being made in Radio, Television and Electronics. It is **TIME TESTED**, too. National Schools has been training men for more than a third of a century. It is the very same training that has helped thousands to more pay and greater opportunity.

You owe it to yourself—your future—to read the book "Your Future in Radio, Electronics and Television"—**FREE** to you when you send in the coupon.

NATIONAL SCHOOLS

LOS ANGELES 37, CALIFORNIA EST. 1905



MAIL OPPORTUNITY COUPON FOR QUICK ACTION

National Schools, Dept. 3-RC

(Mail in envelope or paste on penny post card)

4000 South Figueroa Street, Los Angeles 37, California.

Mail me **FREE** the books mentioned in your ad including a sample lesson of your course, without obligation. I understand no salesman will call on me.

NAME AGE

ADDRESS

CITY STATE

Include your zone number

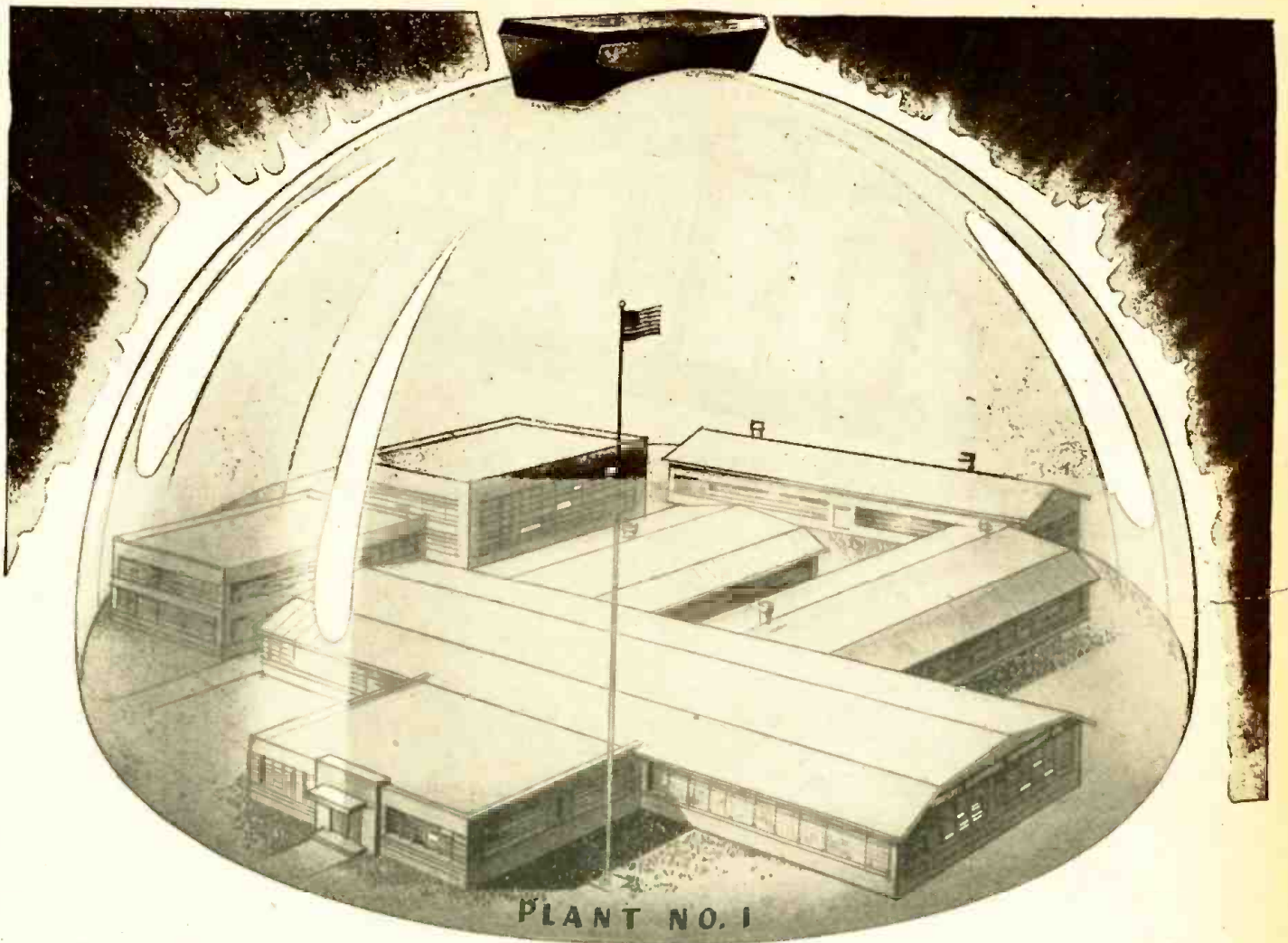

"DUSTLESSTOWN, OHIO"

● It's the little things that loom biggest in the manufacture of delicate electrical measuring instruments. Little things like specks of dust or breath condensation can play havoc with accuracy. That's why Triplet Instruments are made in spotless manufacturing departments; why the air is washed clean, de-humidified and

temperature-controlled; why every step in their mass production is protected. As a result Triplet Instruments perform better, last longer and render greater service value.

Extra Care in our work puts Extra Value in your Triplet Instrument.

*Precision first
...to last*



Triplet

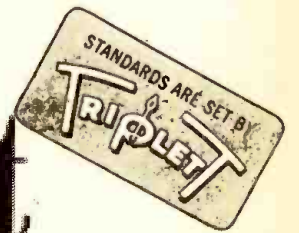

ELECTRICAL INSTRUMENT CO. BLUFFTON, OHIO

RADIO-CRAFT for MARCH, 1945

"Pay or Squeal" Radios

. . . . A new idea, "Subscription Radio" is now on the horizon Will the American public pay from 5c a day upward for the privilege of listening to advertising-free radio?

HUGO GERNSBACK

SINCE 1941 the radio industry has heard off-and-on about "Subscription Radio"—new to America. In Europe and in many other parts of the world the American type of broadcasting—interspersed with advertising—is unknown. In England, for instance, it costs the listener approximately \$2.00 a month for the privilege of listening to his radio. The fee must be paid every month to the government, which supplies the radio entertainment, news, drama, etc., and controls all radio channels. There is no advertising of any kind.

In the United States, the use of radio has been free to all ever since the advent of broadcasting. There has always been a good deal of objection to broadcast advertisements, particularly the more blatant type. This in turn has set many people to thinking whether it would not be possible to furnish advertising-free radio programs.

Having been eminently successful, the Muzak interests, who started advertising-free music in the East, over leased telephone wires, thought to apply the same principle to radio. The idea in a few words is to use three radio-wave bands:

1. Continuous fine music.
2. Continuous popular music.
3. Talks, news, consumer news, reviews, rebroadcasts, etc.

Then the projected broadcast company will superimpose on the radio carrier waves a heterodyne whistle. Then when you tune in on these programs only cat calls and bird whistles will be received. The broadcast company then will install, upon request from you, a special filter. This will clear radio reception and you will then be enabled to listen to an advertising-free radio program. Rental of the filter will be from \$6.00 to \$18.00 a year, depending on Federal regulations. The subscription rate would be payable either by the month,—the broadcasting company billing you for their service,—or another alternative whereby a coin box could be attached to the filter in which the subscriber would deposit coins, similar to a telephone coin box or coin gas meter. In either case, if the subscriber did not pay the rental, the filter would be taken out so he could no longer listen to the advertising-free programs.

It should be noted that this project is no longer in a nebulous state, indeed it has the backing, not only of a wealthy corporation, but associated with it there are some outstanding men. The name of the corporation is the *Subscription Radio, Inc.* The sole owner of the company at present is William Benton, of the Advertising Agency of Benton & Bowles (Chester Bowles is head of the *Office of Price Administration*, who may resign to join the company). The directors besides Benton are Beardsley Ruml, chairman of R. H. Macy & Co., and Robert Hutchins, president of the University of Chicago. James L. Fly, former chairman of the FCC, is also interested in the company, for the good reason that he is chairman of the Associated Music Publishers, which latter is tied up with Muzak, owned also by Benton.

This formidable array of talent must be taken seriously and a number of interesting speculations occur on the proposal. It was noted that in the last FCC (Federal Communications Commission) allocations rulings, the Commission turned down the application of Subscription Radio, Inc., for radio wave channels. Said the FCC:

"No specific portion of the spectrum is being allocated for a subscription radio service. . . ." This seems significant because a very strong bid for channels was made by Subscription Radio, Inc., but so far the FCC has resisted the request. It seems likely, however, that sooner or later we will have with us some form of subscription radio which for want of a popular name I have dubbed "*Pay or Squeal*" Radio.

There are many pros and cons regarding the proposed scheme. To begin with, American radio—which from its very beginning has sponsored advertising—has become the greatest radio force of any country in the world. That point should never be forgotten. The American public has felt that by getting its radio broadcasting free, it should swallow the advertising with good grace—which so far it has done. But lately, radio advertising, as recognized by many critical observers, has tended to grow out-of-hand. The major networks, as a rule, are not offenders of the most blatant type in radio advertising. It is the small and independent stations which belch forth

(Continued on page 390)

Radio Thirty-Five Years Ago

In Gernsback Publications

FROM the March, 1910, issue of MODERN ELECTRICS:
 Condensers for the Production of Electric Oscillations, by *William E. Smith*.
 Spark Telegraphy vs. Wave Telegraph? by *Moore Stuart*.
 A Simple Aerial Switch.
 A Duplex Wireless Receptive System, by *George F. Worth*.
 German Wave-Control Device, by *Berlin Correspondent*.
 Wireless Visible in Arc Lamp.
 The Peukert Generator.
 A Small Transformer, by *Louis Potter*.

HUGO GERNSBACK Founder	
Modern Electrics	1908
Electrical Experimenter	1913
Radio News	1919
Science & Invention	1920
Radio-Craft	1929
Short-Wave Craft	1930
Wireless Association of America	1938

Pancake Tuner, by *A. C. Marlowe*.
 A Simple Hot Wire Ammeter, by *C. W. Schwartz*.

Some of the larger libraries in the country still have copies of Modern Electronics on file for interested readers.

Precaution Against Kickbacks, by *Cyril C. Lots*.

Helps for the Amateur.
 New Wireless Insulator.
 A Simple Lead-in.
 A Simplified Aerial Switch.
 The Advertising Section had the following interesting advertisement:
 "The Wireless Telephone," by Hugo Gernsback. This was the first book in print on the radiophone. J. J. Duck of Toledo, of radio fame, advertised their Ferron Detector. This was an iron pyrite detector, tens of thousands of which were used at the time.

BOYCOTT of certain advertised goods is being forced through the use of certain types of commercials, it was revealed last month by Harry Bannister, manager of WWJ in Detroit. His station recently banned all transcribed commercials.

A second result of disgusting commercials, letters to Mr. Bannister indicated, was limitation of set use. The radio would be turned off when a bad commercial came on, and might remain turned off till some special program was desired. This reduces set use, penalizing the sponsor whose blurbs are in good taste as well as the offender.

About half of almost 200 letters received during the month after the transcribed commercials were banned show the writers to be aggressively resentful and hostile towards certain spots. Mr. Bannister's action is looked upon as an example of intelligent and courageous leadership and he is called "one of the great benefactors of mankind" who has shown "mercy toward the feelings" of the audience.

A writer complaining about a soap commercial turns the radio off when the ad comes on, says others at the bridge and pinochle clubs have the same reactions.

In upstate New York a club has been formed whose members are pledged never to buy a product, if it can be helped, that has a singing commercial.

BROADCAST stations in the United States increased from 912 to 924 last year, says the FCC annual report which was submitted to Congress last month.

Three of the new stations are in Texas, and two each in Mississippi and Michigan, with the others scattered in various states from Atlantic Massachusetts to Pacific Washington.

On the basis of operation under the network rules, for a full year prior to June 30 of last year, the FCC reported "it is apparent that program service throughout the nation has benefited through increased competition between networks and the extension of network service to a greater number of stations."

The Commission revealed June operation of 47 FM stations, with listeners estimated to be using 500,000 sets. Applications for 202 new stations were then on file—the number is now much higher.

Six commercial and two experimental telestations were in use, with 52 commercial applications still on file.

REVISION of the Communications Act, especially as it affects the Federal Communications Commission, was proposed by Representative Holmes of Massachusetts in a bill introduced last month.

According to the Massachusetts representative's plan, the FCC would be divided into two separate sections, each with three members. One of these would handle radio and the other public communications. The chairman would not be a member of either three-man group.

The right of appeal for applicants whose requests for construction permits have been denied, stations whose licenses may be revoked, or persons "aggrieved or whose interests are adversely affected" would be considerably liberalized. Provision is made also for Supreme Court review.

A provision to the act is also proposed which would prohibit the FCC from discriminating against any applicant on the grounds of color, race, type of business, politics, etc. This would clearly rule out any FCC consideration of the advisability of newspaper holding radio licenses; etc.

The bill has been referred to the Interstate Commerce Committee.

Radio-Electronics

Items Interesting

300,000 jobs in television were forecast last month by T. F. Joyce, General Manager of the RCA-Victor radio, phonograph and television department.

"If the frequency allocations for television and the standards for broadcasting established by the FCC will allow for the immediate development of television, once our enemies have been defeated and the War Production Board gives to the industry the go-ahead signal," said Mr. Joyce, "then it is my belief that by the end of the fifth full television production year, the billing of the radio television industry, in terms of retail pricing, will be approximately \$1,440,000,000, as contrasted with the 1941 retail value of approximately \$620,000,000. Or, expressing this in terms of jobs that will be available at the end of the fifth full television production year, television means:

"67,000 more jobs in radio manufacturing.

"15,000 more jobs in broadcasting stations. (This does not include the employees who would be given employment by the radio and television business, such as artists, writers, directors, stage set designers, advertising agency personnel and others—all of whom are needed to operate television stations and television networks. Television's requirements in this direction will be many times greater than the employment provided by the radio broadcasting industry.)

"135,000 more jobs in retail and wholesale distribution.

"85,000 more jobs for radio-television service men.

"Or a total of 300,000 new jobs."

INSPECTION of rocket fuel has been added to the wartime duties of Westinghouse x-ray sets, according to a last month's release from that company. Rocket fuel is extruded in solid form. Any voids in the rocket sticks mean loss of range, uneven propulsion of the shell, and other faulty operation. The function of the x-ray sets is to detect those voids.

The x-ray sets themselves are not unusual, being virtually standard 220-kv factory inspection-type sets. But the hazardous nature of the product requires that they be provided with an unusual enclosure. This is a lead-lined chamber equipped with a sensitive temperature indicator and photoelectric tube that turns on a veritable flood of water from nozzles should a jet stick start to burn. The chamber is provided with lead diaphragms that blow outward on any sudden build-up of internal pressure. The operator positions about the x-ray chambers were chosen to permit unrestricted escape through the emergency exit doors of the building should an accident occur.

The x-ray inspection of the rocket fuel is essentially automatic. Small carriages with the sticks lying directly on x-ray plates are passed into the chamber through a door on one side. The lead-lined doors close automatically, the exposures are made, and the door on the opposite side opens automatically for the removal of the carriage.

APPEALING for better taste and better selection in news broadcasts, the *St. Louis Post-Dispatch* last month initiated a campaign against interlarding news commentaries with repugnant commercials.

Accompanying a leading editorial, a cartoon represented a citizen seated before his radio, "enjoying" a news program which blared: "Warsaw liberated, buy our laxative; American casualties, try our pills." The editorial pointed out that "practically all listeners have relatives or close friends in the armed services and their interest in newscasts is quite personal, quite emotional and sometimes terribly tragic as they hear the names and stories of their loved ones in the news."

Stating that "the public today listens to radio news with reverence and solemnity," radio was urged to respond in kind and clean up "what has become one of the most important show windows in radio," concluding: "A general step by the entire industry adding dignity to the news programs would certainly be to the advantage of all concerned."

HOMING instincts of pigeons are affected by radio waves, reported the Signal Corps in a release last month.

The Corps, which used large numbers of the birds, recently undertook a series of tests to determine whether this was the case, and to seek underlying causes, if the effect should be noted.

Three sets of ten birds each were released from a radio station ten miles from the control loft. Each test consisted of releasing five birds when the station was transmitting, and a second five with it shut down.

Those birds released while the station was transmitting seemed completely bewildered. They circled erratically, very close to the station, for fifteen or twenty minutes, then took off uncertainly for their lofts, requiring a total of 42 to 52 minutes to complete the ten-mile flight. The birds that were released while the station was silent made the usual brief circling, then took off promptly for the home loft with no confusion whatever, covering the total distance in 18 to 21 minutes. There was very little difference in the results of the three tests. In every case the birds that were hampered by radio transmission bungled their tasks. In every case where there was no transmission the birds performed with the easy confidence which pigeoneers have learned to expect. All the birds were of similar type and training. All flew under practically identical conditions of wind and weather. Not a single bird upset the theory by flying noticeably better or worse than his mates under the same handicaps or advantages.

The Signal Corps is slow to accept any theory on the basis of a few tests, and there will be many more before the connection of radio with the homing instinct is conclusively established.

Monthly Review

to the Technician

ADEQUATE engineering staffs for the FCC was one of the recommendations of the Lea Committee which handed in its report last month. Such a staff should be large enough to make technical examinations of applications and to engage in research and keep abreast of all new developments; and should be adequate to monitor the wavebands "against unauthorized use of radio and to eliminate interference to authorized radio circuits." Sufficient personnel "to handle applications promptly and procedures designed to permit expeditious discharge of this function" was also recommended.

The value of the Radio Intelligence Division and of the Foreign broadcast Intelligence Service, question of which was one of the reasons for calling the Committee into being, was upheld, it being pointed out that "unauthorized use of the radio spectrum cannot be tolerated," and that a reasonably accurate knowledge of enemy radio propaganda was necessary to counteract it. It was "natural and logical" according to the Committee, that the FCC be selected as the monitoring agency.

SSIX MORE powerful transmitters began to pour messages and programs into the Far East last month. Rated at 50 kilowatts each, these new facilities almost double broadcasting hours to Japan and carry the voice of America deeper into China, the Philippines and the mainland of south-east Asia, according to the Office of War Information.

Other links recently added to the Far East chain include a 100-kilowatt shortwave station at Honolulu and a 50-kilowatt station on Saipan, which operates on the broadcast frequencies. This latter station, picking up programs from Honolulu and the mainland, can be heard on ordinary civilian broadcast receivers in Japan, and the FCC reports that radio Tokyo is attempting to prevent listening.

Present stations operated for OWI in California include: KGEX and KGEI by General Electric at Belmont and KWID and KWIX by Associated Broadcasters in South San Francisco.

The new stations are: KCBA and KCBF, a dual transmitter, operated by CBS at Delano; KNBA and KNBC, dual transmitter, and KNBI and KNX, dual transmitter, at Dixon by NBC.

SNOW STATIC, well known to radio listeners in cold climates, is especially annoying on television programs, according to a recent report. This type of static appears as large white flashes on the screen.

Complete insulation of the antenna system, to prevent the flakes from giving up their charges has been suggested as a remedy.

Experience with sound broadcast indicate that the same trouble may be experienced in Western areas where sand- or dust-storms are prevalent.

ALLOCATIONS of the high-frequency spectrum from 25 to 30,000 megacycles were provisionally issued by the Federal Communications Commission January 16. Chief points of interest were the moving of FM to a higher frequency; allotment of bands both in the present range and in the ultra-high to television; provision for rural radio-telephone and "citizen" radio for communication between individuals; the setting aside of several channels for railroads; creation of a number of new bands for amateurs; and provision of an area in which diathermy, industrial heaters and other interference-causing devices can operate.

The proposal for FM is to move it up from its present band of 42-50 to 84-102 mc. This provides 90 channels instead of the present 40, and is expected to eliminate sky-wave transmission which sometimes causes disturbing interference. The space between 102 and 108 mc has been left unassigned, and if needed may be allotted to FM later.

Twenty of the FM channels are reserved for non-commercial educational stations. This service, the FCC believes, "may profoundly affect not only American education but our democratic institutions as a whole."

Commercial television is permitted to remain roughly where it is in the lower part of the spectrum. Specifically, it now has 18 channels 6 mc wide at intervals from 50 to 294 mc. The new allocation gives it six channels—also six mc wide—from 44 to 84 mc, and six from 180 to 216 mc. To permit the development of a future system for color and high-definition through the use of wider channels, the Commission proposes space for experimental television between 480 and 920 mc. Whether television should stay "downstairs" or go to higher frequencies was one of the most contro-

(Continued on page 384)

SCHWEINHEILERS are being used on the Eastern as well as the Western front, according to a *Science Service* report last month. Statements from German sources published in England reveal that the Russians are using airplanes fitted with loud-speakers. These talking sky-giants fly low over concentrations of Nazi troops and civilian areas, spreading propaganda designed to lower civilian morale or persuade troops to surrender to the advancing Soviet armies.

AN ELECTRONIC control that automatically synchronizes a new type shutter for aircraft cameras with the bursting of a flash bomb, thus enabling military observers to photograph from high altitudes and at night the destruction caused by their explosives was announced last month by General Electric and the Folmer Graflex Corporation.

Use of this unique control permits the camera to take advantage of the peak illumination of the bomb by beginning an exposure in approximately 1/100 of a second after the flash bursts. After the desired exposure time has elapsed, the control closes the shutter of its own accord. At the same time the camera automatically rewinds the film and gets ready for another picture, thereby saving the observer precious minutes and permitting another picture to be taken automatically as soon as the next bomb explodes.

Brains of this robot control is a sensitive photoelectric cell that acts on the light impulse coming from the bomb. When the flash explodes, the photoelectric cell picks up a light impulse, amplifies it and transforms it into a current to which the shutter responds in less than 1/500 of a second. By using this ingenious combination, an aerial camera, otherwise of use for daylight photography only, can be converted into a camera capable of taking night photographs of the ground in great enough detail to permit the closest military study.

Small enough to fit into a hat box and weighing only nine pounds, this robot device was designed especially for use on reconnaissance planes and bombers. Both photoelectric cell control and shutter are shock-proof in construction. When in use, the control operates on three-billionths of a watt—about the equivalent of the energy spent when a human hair falls 1/10 of an inch.

Apparatus for synchronizing photo exposure with bomb flash is shown dismounted here. Camera is at left, the photocell above, and the electronic apparatus in the box at bottom left center.

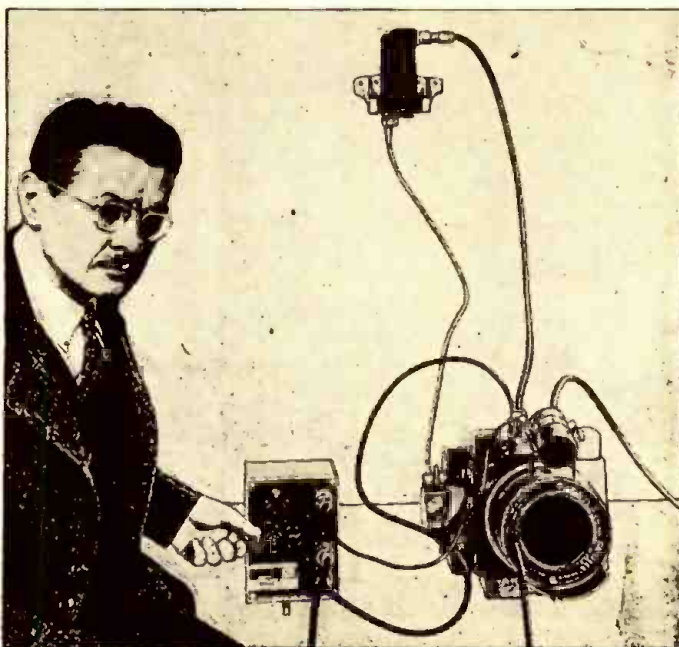

Electronic Flight Control

Attitude Indicators Simplify the Pilot's Problems

By RAYMOND LEWIS

THE instrument panel on modern aircraft is so complicated as to bewilder the layman. A multi-engine plane will have all, or most of the following instruments: Altimeter; Compass; Air-speed Indicator; Engine Tachometers; Fuel

the pilot is forced to handle. Radio and navigation experts have also assumed many of his responsibilities.

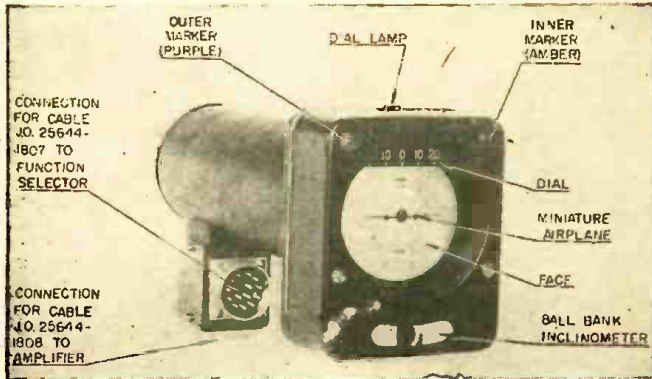

Left — The Sperry Flightray, a universal flight attitude instrument which combines on one cathode-ray screen a number of different readings, freeing the pilot from keeping his eye on several dials at once.

Gages; Rate-of-Turn Indicator; Rate-of-Climb Indicator; Gyro-horizon; Directional Gyro; Oil and Head Temperature Indicators. In addition there are hydraulic, pneumatic and electrical systems, superchargers, flaps, variable pitch props, and de-icers . . . all of which result in a maze of meters, dials, and controls extending from the floor to the top of the cockpit.

Conversion of some of the pilot's manual controls to automatic operation improved the situation. The automatic pilot, automatic mixture controls, propeller pitch control, etc. have greatly relieved the pilot. However, he has not been relieved of the responsibility for their functioning. Monitoring instruments still must remain in view for him to check. The total number of instruments is therefore not reduced.

Another important step, but only practical on the largest aircraft, has been departmentalization of various duties. The Flight Engineer has been adopted as a direct result of this complex set of controls

Combining instruments has been notably unsuccessful for several reasons. Pilots were confused by the indications of multiple unrelated pointers on the same face. Servicing was also complicated, since the failure of any one instrument necessitated the replacement of all the instruments in the case. The only exception has been on such devices as tachometers, where the RPM of two different engines are easily indicated on the same dial face.

A recent approach to the problem of instrument simplification has been the adoption of the cathode-ray tube as an indicating device. Its extreme flexibility as an indicator has become well known through its widespread use as an oscilloscope. The tube allows a wide variety of indications from which a non-confusing combination could be chosen. By the simple expedient of rapid switching or commutating it was possible to produce multiple indications of different forms without mutual interference.

Two separate systems of instrument simplification are based on the cathode-ray tube. The American method, developed by the Sperry Gyroscope Company is identified by the trade name "Flightray," and is shown in the photo. The British system is described as a Universal Flight Attitude Instrument by F. Postlethwaite, who has made the proposals for its design. The Flightray is in actual experimental use. It may be seen in Fig. 1 and the photo.

It will be noted that both cathode-ray tube instruments outline a plane on the screen. In the Flightray, this is actually an integral part of the indicator not formed electronically. The miniature airplane is flown in relation to the luminous traces shown on the screen. Two means of producing the aircraft outline or silhouette electronically are possible. One makes use of existing television techniques. Because of the obvious complications, this method is not considered practical for aircraft use. It would require a model aircraft, complete with moveable flaps and retractable undercarriages, for scanning.

A preferred method consists of making the cathode-ray spot trace out an aircraft

duced by spot modulation and scanning. If suitable variations of voltage are applied to the deflector plates it is possible to trace out any desired outline. This can be done by rotating suitably shaped cams to control the amount of light passing from lamps to the photo cells. On the British instrument different cams are utilized to trace out various parts of the outline; two for the plane outline; two for adding the flaps; two for the landing gear. In operation the outputs from the cams are added arithmetically to produce the deflector plate voltages necessary to trace out on the screen the required aircraft outline. (See Fig. 2)

On the Flightray the desired patterns are drawn on the screen by electrostatic deflection of a pencil beam of electrons within the tube. Wherever this beam of electrons strikes the fluorescent material of which the screen is composed becomes luminous. In order to produce a line or a circle, an alternating voltage is applied to either vertical or horizontal deflection plates in the correct phase relationship to cause the spot to trace out the desired figure. Each instrument in the Flightray system has attached to it a signal pick-up. When this pick-up is centrally located relative to two stationary elements, no deflection is applied to the cathode-ray beam tube. However, if the instrument deviates from the normally set-in position, a differential voltage is produced which is applied to deflect the desired pattern on the face of the tube.

In both systems it should be observed that the cathode ray tube spot does not trace out all the various indications at the same time. On the British apparatus the rotary unit switch as shown in Fig. 2 is required so that the various signals to the CR deflector plates are fed one after another. The aircraft outline is first traced on the screen in a position fixed by the bias voltage applied to the plates, then the spot jumps to indicate the compass bearing and finally moves to indicate the height of the aircraft. The sequence of operation is sufficiently fast to prevent flicker. Flaps, landing gear, or fuel indications are traced at the same time the aircraft outline is applied. On the Flightray there are four separate indications on the face of the CR tube. The various amplifiers associated with each instrument pick-up are sequentially made operative by means of a commutator which applies suitable control voltages to each amplifier in turn. Commutation takes place at a rate well above the persistence of human vision with the result that, though only one line is shown at a time, the resulting pattern is entirely free from flicker.

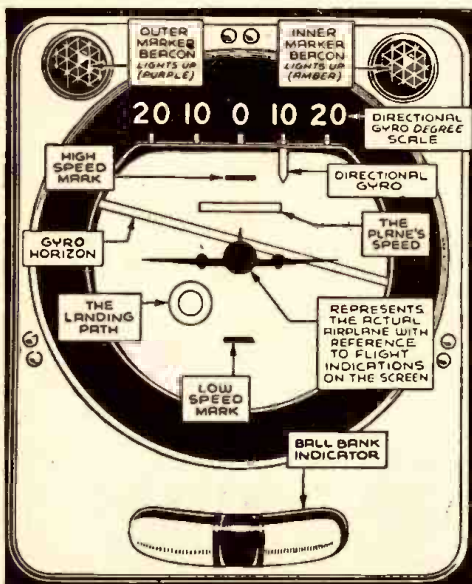

Fig. 1—A close-up view of the Flightray.

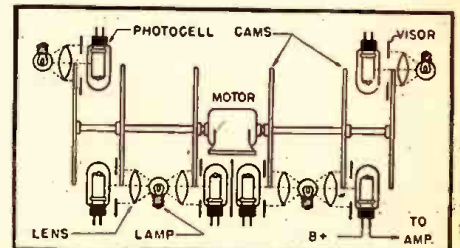
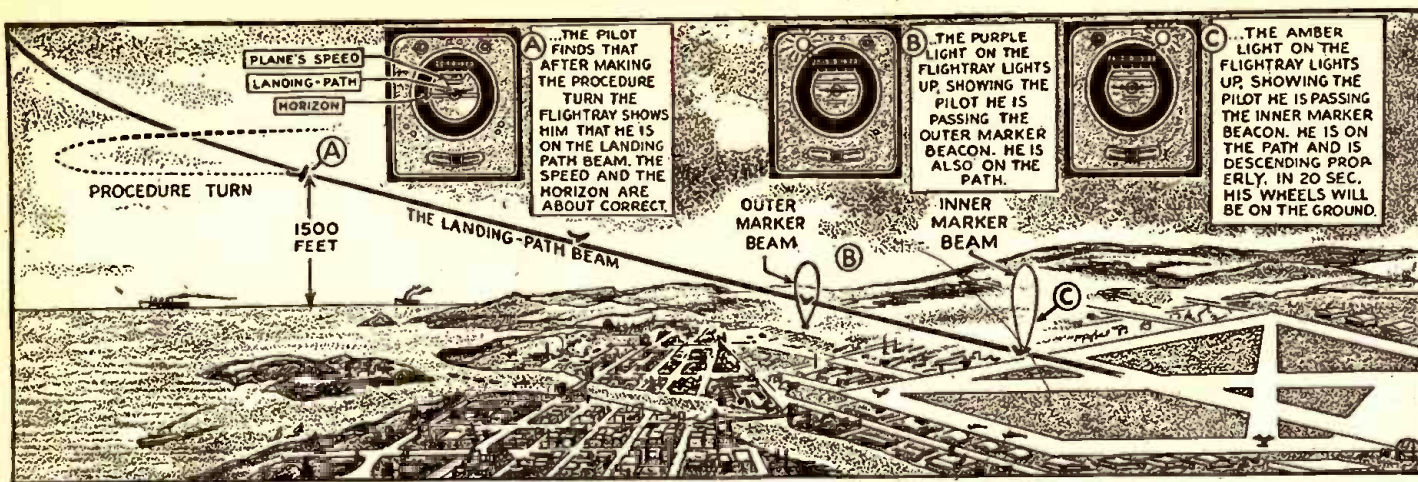

Fig. 2—Mechanical system for producing the aircraft outline on the British instrument.



How the Flightray assists the pilot to bring his plane home, showing all deviations from the glide path and his distance to the field.

The Sperry Flightray is not a primary instrument. While it represents information from many sources, all these sources must be carried. The British system would eliminate the instruments and incorporate all their functions in the Universal Flight Attitude instrument. This means scales and a departure from the purely pictorial representation achieved in the Flightray.

The essential artificial horizon will be handled in one or two ways in the Universal Flight Attitude instrument. The artificial horizon incorporates a vertical gyroscope operating on suitable gimbals. When the nose changes position, in any direction, the gyro remains vertical while the horizon bar moves up or down, or tilts to the right or left, but in the opposite direction. Either a separate instrument would be carried to give these horizon indications, or, as shown in Fig. 3, the horizon could be made to perform these functions while occupying a central position on the horizontal diameter of the cathode-ray tube cover glass.

The British system proposes the use of a master unit containing many of the instrument mechanisms at present placed on the panel. This is in direct opposition to the Sperry argument against placing more than a single instrument in a case.

A visual indication of proper turn and bank is obtained by introducing distortion, produced by a pentode which amplifies the signal produced by the cam of the pair required for the aircraft outline. An over-banked turn in one direction or an under-banked turn in the opposite direction will produce the same distortion, which causes the wings on the outline to change their length. The position of the horizontal bar clearly shows which way the aircraft is banked (Fig. 3).

The output from the magnetic or electronic compass will consist of two potentials which when fed to the cathode-ray tube will position the spot near the scale surrounding the screen. When ice forms on the leading edge of the wing a simple device is used to increase the brilliancy of the spot as it traces out the upper surfaces of the wings. The diagram can be made to appear as a broken line if a low level fuel warning device is incorporated in the fuel system.

The air speed device proposed for the Universal Flight Attitude instrument can vary the gain of the outline signal amplifier. The outline of the aircraft would vary with aircraft speed. For convenience an increase in speed would produce a smaller diagram. A further advantage would be the elimination of the existing air-speed reading, by substituting a ground speed measurement. Making use of a radio beam and the Doppler effect, such a device would

be ideal to incorporate in the flight attitude instrument.

The rate-of-climb instrument measures the vertical velocity by virtue of the changes in atmospheric pressure. As in the Flightray, it could also be obtained from an attachment to the altimeter. An electrical pickup unit and amplifier could convert the output of this instrument into a biasing voltage. When fed to the vertical deflector plates of the CR tube it would move the aircraft outline in the appropriate vertical direction, the displacement being a direct measure of the vertical velocity of the aircraft. A suitable scale could be engraved on the cover glass as shown in Fig. 3.

The height of the aircraft would be indicated by a spot on the vertical scale running up the center of the cover glass. Altitude is generally indicated by measuring the prevailing atmospheric pressure. In an electronic instrument, such as this, the use of a radio altimeter giving clearance in feet over the terrain, fits well into the general pattern of readings. The radio altimeter works on the principle of measurement of the time interval required for a radio wave to reach the ground and return to the plane after it has been reflected from the ground. A knob would be provided to determine sensitivity. This is in effect a vernier arrangement, enabling readings in multiples of either hundreds or thousands of feet. The second knob on the right of Fig. 3 is used for this purpose. The third position of this knob could enable the outline to be used with a blind landing approach system such as the new CAA VHF visual range. For this system the position of the outline on the screen

could indicate the actual position of the aircraft relative to the landing beam. If the outline were in the middle of the screen the aircraft would be heading down the beam "on course." The first knob in Fig. 3 is used for setting the course, since the instrument is in effect a modified automatic pilot.

The Sperry Flightray was developed from a different viewpoint. The designers felt that in the interest of simplicity, scales and numerals should be eliminated as far as possible. It was decided to derive immediate flight information from the fol-

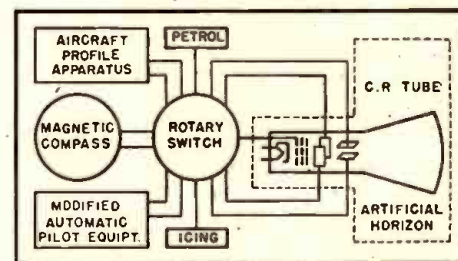

Block Diagram of British flight instrument.

lowing flight instruments: Gyro Horizon, Direction Gyro; Altimeter; Air Speed Meter; Radio Compass and Radio Landing Meter.

The aircraft attitude and position must be shown at all times. The gyro-horizon technique has been mentioned in connection with the British instrument. It is, of course, used in the Flightray. In order to bring the airplane back to a normal attitude or position, the miniature plane (Continued on page 375)

Fig. 3—A layout of the cathode-ray tube Universal Flight Attitude instrument. The electronically-traced airplane acts as its own indicator, giving information by its size and position on the screen.

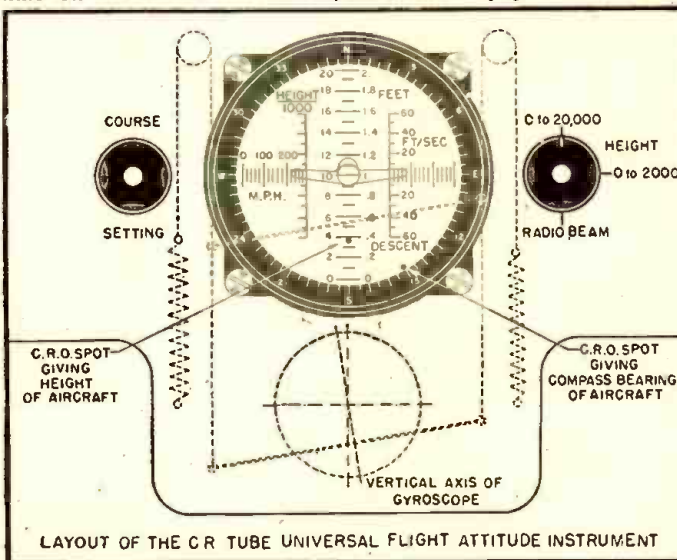

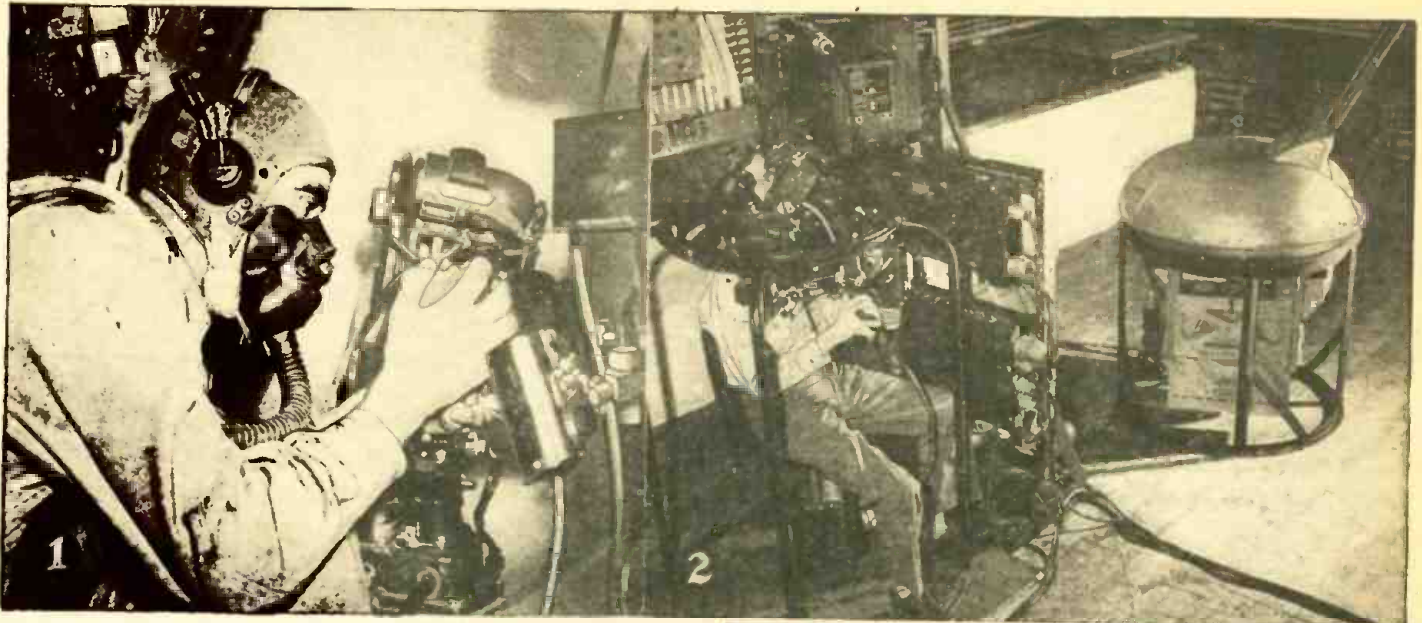

Courtesy General Electric Co.

- 1—Sighting through the nose in the B-29 forward control position.
- 2—Demonstration of sight and turret set up in a New York hotel.
- 3—The "black box"—mysterious brain of the gun-control system.

COVER FEATURE:

B-29 Electronic Gunsight

SECRET of B-29 successes in the Pacific war theatre is that the long-range bombers carry just enough fire power to enable them to do without fighter escorts and yet conserve cargo capacity to permit a heavy load of bombs. The weight of armament is cut down by use of a new computing gunsight, which permits one gunner to bring the ship's full fire-power to bear on an enemy approaching in any direction. By simply dropping the firing switch, he can relinquish control to a gunner in one of the plane's other stations.

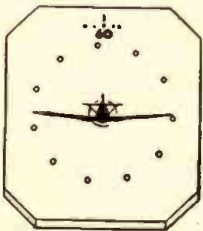

instrument. Then he focuses the circle of dots (see left) from tip to tip on the image of the enemy plane, and keeps it there by moving the sight either to right, left, or up and down. From the size of the plane and the size of the luminous circle in the sight the range is computed by instruments. On the basis of the range and the movement of the sight to keep the enemy plane in the set circle of dots, the speed of the target plane is arrived at through a gyroscope functioning on the sighting device. The range and speed of the enemy is relayed by electrical impulses to the computer.

Total effect is that a "relatively small" number of .50-caliber machine guns and a 20-millimeter cannon are made so effective that—as reported by one Army Air Forces officer—"the gunnery system functioned perfectly and the gunners co-ordinated their fire so well that they put a metal fence around the besieged Super Fortress."

Added to the reduction in weight permitted by concentration of the ship's total fire power under one control is that effected by cutting the gun turret down to a size just sufficient for the gun itself, as compared to the older turrets in which gun and gunner swung together.

The new apparatus, which was developed jointly by the Army Air Forces and General Electric, operates as follows:

The sight is in a small box, open at both ends, containing a slanting glass. When a gunner detects an enemy plane on the sight, he registers the size of the fighter on an

The sight is moved by two handles. The trigger switch is on the left handle of the ring sight. The pedestal sight has two triggers. The action switch is on the right. When the gunner presses on the action switch, the turret that he controls is in operation. When he is not holding that handle, the gunner who has secondary control of the particular turret can take it over. The sighting equipment is so devised that a gunner can sit and stay physically relaxed while using it. He has no trouble in keeping a swiftly moving enemy plane in the circle of luminous dots, because the sight moves smoothly and easily.

Electrical parts to move the guns instantly and accurately in response to quick movements of the sight include electronic equipment and a series of motors. Selsyn motors on the sighting stations and gun mounts team together in synchronization as though they were on a solid shaft, rather than apart and connected only by electricity. The Selsyn motor on the turret sets the

tempo for more powerful equipment, which moves the guns. This power is sufficient to lift a 200-pound man hanging on the ends of the guns.

Since the navigator has the instruments showing altitude, outside temperature and speed of the B-29, he sets dials sending that information to the computer. Facts on the altitude and outside temperature make it possible for the air density to be determined, which in turn figures in an important way on how the path of the bullet will be curved by windage.

The electronic and mechanical brain in the little black box goes to work on the information it has been given by other elements of the system. These include the range and speed of the enemy aircraft, its angle from the B-29, speed of the plane from which the bullets are to be fired, and the air density. Its job is to figure out instantly where the bullet and enemy plane would meet, and correct the pointing of the guns. Here is what it does:

1. *Lead:* While a .50 caliber bullet is traveling 800 yards at 30,000 feet altitude, a fighter plane going 400 miles an hour at the same height will move forward 110 yards. Thus, the guns have to be fired at the proper angle in front of the enemy plane to hit it, just as a hunter must fire shot ahead of a duck in flight to kill it. The computer determines the lead, making the guns point well ahead of where the gunner actually is focusing his sights.

2. *Windage:* A bullet fired broadside
(Continued on page 369)



Votes by Radio

An Electronic Machine for Opinion Polls?

By T. R. KENNEDY

SOME day a President of the United States may be elected "electronically." A system has been devised and is now under development to gather quickly and accurately the opinions of representative groups of Americans on all sorts of questions of interest in our national life. If this can be done, and it seems that it can, it can be used to poll the nation to elect a President.

This is not as fantastic as it seems. It has been learned that a Radio Technical Planning Board panel has recommended the allocation of a twenty-megacycle radio band to experiment with the electronic-polling idea in the micro-waves between 2,500 and 5,000 megacycles. If the plan is carried out as now projected it will consist of one or more special central radio stations to communicate with a group of "respondent receiver-transmitter" outfits distributed among the groups to be polled.

HOW IT'S DONE

Each group—perhaps only a few hundred—would be selected in a given polling district, say a county, which might easily be covered by one central radio station. Additional stations would be located centrally in adjacent areas and have different groups to be polled. All questions to be asked would be worded so the answers might be "yes" or "no" or "very good," "fair," "no opinion," "poor," "very bad," etc. To vote, each person in the key groups would press one of a series of buttons on one of the respondent receiver-transmitters furnished by a committee in charge.

The voting machine actually would be a miniature transmitting station equipped to send out micro-waves more than powerful enough to span the distance to the central receiver station, where the votes are registered. Inside the box, perhaps, will be a series of cams—the "no-voting" button setting one cam in motion, the "yes-voting" button another cam. Each cam in turn would set in motion a series of contactors designed to send out a series of high and low pitch buzzes or impulses, which, upon arrival at the central receiving station, would vote "yes" or "no" just as accurately as if the voter himself went to an election district voting booth in the regular way.

PRIVACY GUARANTEED

Questions to be voted upon would reach each voter over an ordinary radio set in accordance with a prearranged broadcast schedule, or be transmitted by facsimile from district headquarters over the special micro-wave channel directly to the voting machine. On the micro-wave channels the electronic voting machine might be set in operation when a vote is to be taken through a system known as an "alert" receiver, which would turn on the whole mechanism when a certain type of electric impulse is transmitted from the central station. A buzzer or loud-speaker would then warn that a vote-taking was imminent. Failure to vote, if too frequent, might be regarded as cause for removal of the apparatus to the home of an

alternate voting member in the polling district group.

Each voter would be supplied with a key to open the instrument and prevent unauthorized persons from tampering with it. Red and green lights would flash on and off—the red to indicate the machine at ready, green indicating the vote is ready to be cast, and finally another red light indicating the balloting has ended. The key to the instrument would then be withdrawn until another balloting time is announced.

The inventor of the system is Dr. Alfred N. Goldsmith, New York consulting engineer and prolific inventor, who has called it "centercasting." Dr. Goldsmith foresees the possible use of a single micro-wave-length to conduct a poll—say in a city or county—with additional micro-wave channels for more extended operation for State-wide or national polls.

In other words, the centercasting system of voting or polling conceivably is something that may help solve many of tomorrow's problems of sampling public opinion or electing an official. The electorate, on the other hand, will have to be carefully selected to represent every phase of American life. As complicated as this seems, it is possible to select groups to do the job accurately. Professor Theodore Brown of Harvard has shown that "the mathematical chances

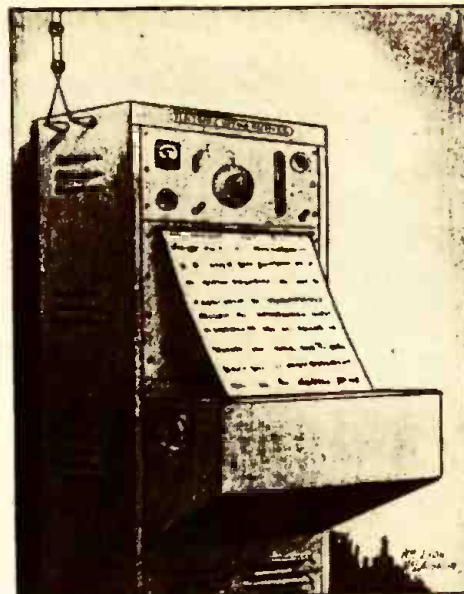

Receiver would count and tabulate votes as received, keeping returns up to the minute.

are 997 in 1,000 that random sample of 900 will be accurate within 5 per cent where opinion divides evenly." To gain greater accuracy the size of the group is increased.

To be thoroughly reliable as an indicator of public opinion each voting group, of course, would have to be a complete and homogeneous sample, in substantially the same numerical proportion as the whole voting population—of all political parties, rich and poor, old and young, farmers and urban dwellers, of all faiths. It would take time to set up such groups, but radio could, it seems, gather the votes in minutes—or seconds.

Reprinted by courtesy of the *New York Times*

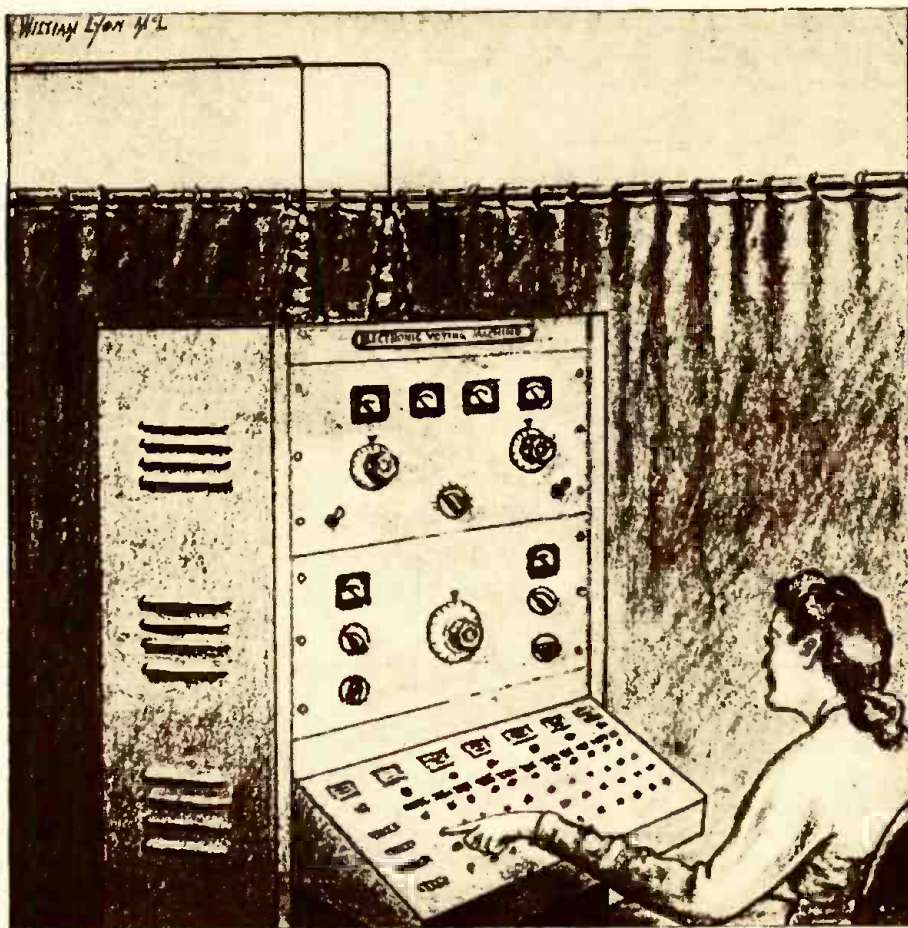

A transmitter-voting-machine of the future?

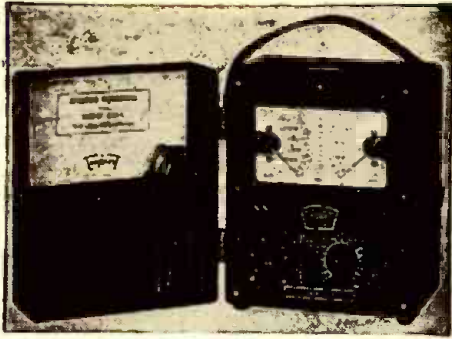

Triplet 1200 E, an easily-adapted model.

Meter Adaption

For High-Resistance Measurement

By ALFRED SHORTCUT

A RADIOMAN often desires to measure a value of resistance not within the range of the test equipment he owns. He may wish to measure the leakage resistance of high-voltage cables, transmitting condensers, or socket insulation. These resistance values may be between 5 and 500 megohms and cannot be read by most service instruments. Twenty- or twenty-five-thousand ohm-per-volt meters usually have ranges up to 30 megohms, but seldom extend above this limit.

The Hickock model 133 B analyzer uses a 40 micro ampere meter movement. Because of this low current requirement only 10.5 volts of ohmmeter battery is required for the highest resistance scale. This makes it easy if it is desired to multiply the meter scale. Figure 1 shows how this may be done by the addition of one resistor and a battery.

To use this circuit, set the ohmmeter to its highest range and connect the external battery and resistor. Short the ohmmeter leads and adjust the 133B zero adjustment for zero ohms. The ohmmeter will now read resistance values up to 100 megohms, or

10,000 times the fundamental scale.

If it is desired to make the ohmmeter AC operated a power supply may be made to replace the battery. Such an arrangement is shown in Fig. 2. The zero ohms adjust-

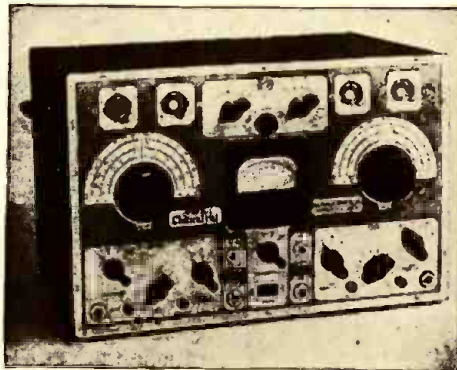

Range of the RCA Chanalyst can be extended.

ment is put on the power supply instead of using the one in the test set. Voltage regulation is used to insure proper operation. Set the Hickock 133B to the 40 Micro-ampere scale and connect the test leads to the terminals used to read this value of current. Connect the power supply, short the ohmmeter leads and make the meter read zero ohms by means of the 200,00 ohm potentiometer on the power supply.

A simpler arrangement would be to make the power supply AC-DC operated but this has the disadvantage that the set cannot be used on any circuit that is grounded. Therefore it is better to avoid this type of pack, as its use may result in a ruined meter.

While desirable, it is not absolutely necessary to use voltage regulation and the Vr-105-30 tube may be replaced with a 7,000 ohm, 3 watt resistor in either Figure 2 or 3.

The Triplet 1200 E is also a 40-Micro-ampere meter and can be used to measure high resistance values. It uses a 22.5 volt battery on its highest resistance scale and reads values of resistance up to 40 megohms.

To multiply this scale by 10 or increase the range to 400 megohms, the power supply shown in Fig. 3 may be used. While voltage regulation is shown as before it can be left off by replacing the Vr tubes with a 15,000 ohm 5 watt resistor.

Those individuals fortunate enough to own a Jr. Voltomyst have at their disposal an instrument that will read up to 1,000 megohms of resistance. The reason this meter can read such high resistances is the fact that it draws such little current during operation. Since the voltmeter is of the electronic type it has an input resistance of several megohms and the current drawn from the ohmmeter battery on high ranges is negligible. For this reason it is possible to read up to 1,000 megohms with only 3 volts of ohmmeter battery.

It may be well to consider at this point the use of a 1,000 ohms-per-volt meter to read high resistance values. It is possible to use this type of meter but in order to read high values it is necessary to use very high power supply voltages and danger of shock exists.

It is possible, quite simply, to modify the RCA Chanalyst to read high resistances with the circuit shown in Fig. 4. A chart of resistance values vs. voltage reading may be calculated by use of the formula given earlier. The advantage of this arrangement is that it will read higher values of resistance than most meters and still does not require dangerous voltages. To use the circuit turn the Chanalyst on and allow it to warm up. Set the meter to zero (mid scale) by means of the zero adjustment on the unit. Connect the ohmmeter power supply and turn on the battery switch. Short the leads and adjust the 250,000 ohm potenti-

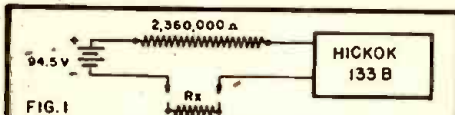

FIG. 1

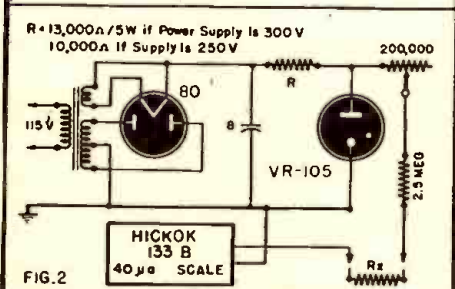

FIG. 2

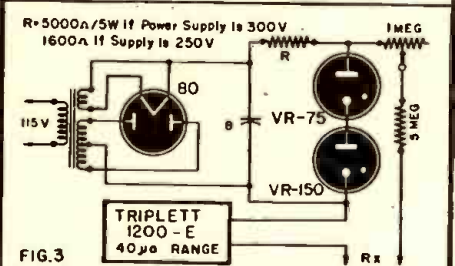

FIG. 3

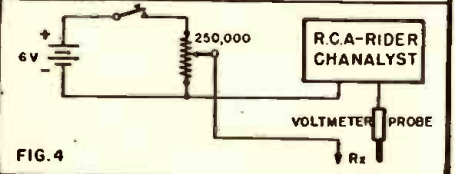

FIG. 4

Figs. 1 and 2—Battery and A.C. power supply for Hickok 133 B. Fig. 3—Another power pack. Fig. 4—Hookup to extend Chanalyst's range.

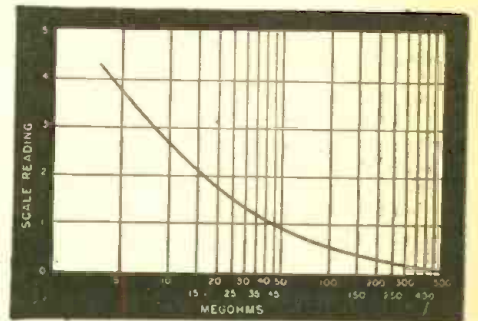

Fig. 5—Graph, meter readings vs. megohms.

ometer (ohms zero adj.) for full scale reading on the Chanalyst 5 volt scale.

Table 1 gives a table of resistance values that will give the indicated voltmeter readings. These values have been plotted on a graph in figure 5 so that it is possible to determine the approximate resistance for any meter reading.

(Continued on page 379)

Voltmeter Reading	Resistance in Mcgohms
4.8	.5
4.6	1.0
4.4	2.5
4.2	3.1
4.0	3.8
3.8	4.5
3.6	5.3
3.4	6.2
3.2	7.2
3.0	8.4
2.8	9.7
2.6	10.1
2.4	12.0
2.2	14.0
2.0	16.5
1.8	19.5
1.6	23.5
1.4	28.25
1.2	35.0
1.0	45.0
0.8	53.0
0.6	81.0
0.4	127.0
0.2	289.0
0.1	539.0

Table 1

RECORDING ON WIRE

By I. QUEEN

RECORDING on magnetic wire or tape is used for voice analysis, business purposes, Signal Corps work and broadcasting. The latter has been especially popular in Europe for a number of years. Wire recording is economical, simple and possesses the unique advantage that it may be used over and over again by simply "erasing" the sound on it. One disadvantage is that the fidelity obtainable is not as good as with other methods.

Magnetic recording was originated in 1898 by Valdemar Poulsen, who used a steel wire which passed through a changing magnetic field and became correspondingly magnetized. When the wire again was passed through a coil (possibly the same one) the varying magnetic field induced an EMF which reproduced the original sound.

The curve of magnetic intensity vs. magnetization is not a straight line at its lower end, so much distortion results from this method. A later system provided for original magnetization of the wire and subsequent demagnetization by the changing magnetic field (due to an impressed sound frequency voltage). Better fidelity is thus possible since the upper end of the magnetization curve is more nearly linear. However, a magnetized wire is very sensitive to external influence and is easily demagnetized by stray fields and shocks introducing noise.

The recording medium may be either a round wire or a flat tape. Wire is easily obtained, but tape allows simplification of apparatus since it cannot twist during travel. Because of the latter characteristic, wire is recorded longitudinally or through the wire (Fig. 1-a), and tape transversely or across the medium (Fig. 1-b).

Wire speed has a marked effect upon fidelity. Fig. 2 shows a typical curve of

output vs. frequency for three different speeds. Each characteristic is also a function of the type of medium, its size and the strength of magnetizing force.

A series of inventions relating to magnetic recording and assigned to the Armour Research Foundation of Chicago has recently been disclosed by the inventor, Marvin Camras. These include a complete design for a modern wire recorder, new and improved recording methods, and several accessories of great importance for making better records.

Fig. 3 shows front and side views of a preferred form of recorder. The top panel contains the two reels for holding the wire, which may be of .005-inch diameter high carbon steel. Friction and guide rollers keep the wire in position while passing through the recording and erasing heads. In recording and reproducing, motion is from left to right, after which the wire is rewound back to the left-hand reel. On the bottom panel is the speaker, footage indicator, motor switch and other controls. The neon bulb indicates volume. Below it is the record-playback switch, mounted between two pilot bulb jewels, the green to indicate when recording is taking place, the red for reproducing. Below these are two knobs, one controlling volume, the other a combined tone control-power switch. The motor switch has three positions: forward, stop and reverse.

The amplifier (shown in the side view) is of conventional three-stage pentode design. A high-frequency oscillator is also incorporated, its function being described later. In the output of the amplifier is incorporated an equalizer to improve fidelity. Fig. 4 is a schematic of the recording head and connections. For recording, the amplifier input is connected to a microphone,

while the amplifier output is switched to the recording head through an equalizer. At the same time the oscillator is connected to the erasing coil so that any previous magnetization of the wire is erased. When reproducing, the equalizer and oscillator are not needed and are shorted out. The recorder is now used as a reproducer by connecting its output to the amplifier.

An ingenious method is used to stop the motor as either of the reels approaches complete unwinding (Fig. 5). A cam cylinder on the footage indicator shaft is shaped to have a groove and a raised portion on its circumference. The cylinder rotates only once for a complete winding of wire, and works in cooperation with an armature. As the wire becomes unwound in one direction, the cam follower drops into the groove, lifting the left end of the armature and pushing the switch into neutral. If the wire had been moving in the opposite direction (switch in down position) it would have caused engagement of the cam follower with a raised portion. The left end of the armature would then be pushed down against the abutment and the switch again pushed into neutral.

Connections to the oscillator are given in Fig. 6-a. In this diagram the high frequency and the amplifier output are superimposed in the recording head resulting in a wave shape of Fig. 6-b. This is not a modulation (Fig. 6-c).

Excellent fidelity is obtained when the wire is magnetized by means of a superimposed high frequency on the audio frequency.

The erasing coil is positioned so that the wire passes through it before reaching the recording head during a recording. The high frequency field, which may be in the neighborhood of 16 Kc demagnetizes the

(Continued on page 367)

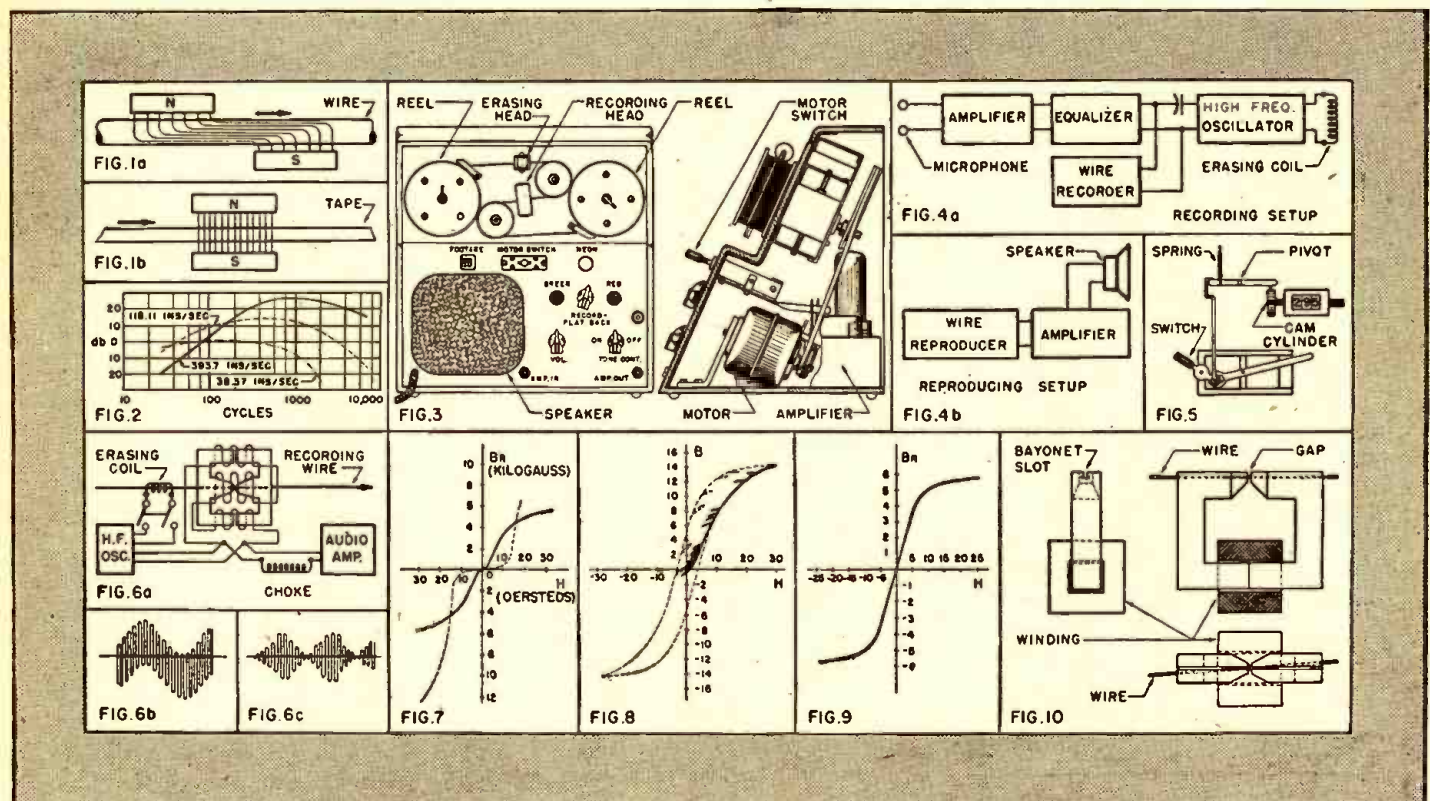

BROADCAST EQUIPMENT

PART VII — TRANSMITTER CONSTRUCTION

By DON C. HOFFLER*

IN the standard broadcast service, the F.C.C. requires that "... the frequency of all stations shall be maintained within 20 cycles of the assigned frequency." This is interpreted as ± 10 c.p.s. However, the frequency deviation in a crystal-controlled oscillator, due to variations in ambient temperature, will often exceed this small tolerance. If it does, it is necessary to maintain the temperature of the crystal at a nearly constant value by placing the quartz plate and its holder in a constant-temperature oven. This is an air-tight metal box whose inner walls are covered with some heat-insulating material such as Celotex, and which contains a thermostat and a heater.

CRYSTAL OVEN DESIGN

The design problem involves the accurate determination of the temperature at which it is necessary to operate the quartz plate. It is necessary that this temperature be above the highest outside air temperature encountered, and is usually around 90° F. This is due to the fact that the heater apparatus can raise the oven temperature if it gets too low, but it cannot lower it if it becomes too high.

When the temperature inside the oven falls below the setting on the thermostat, contacts in the heater supply circuit are caused to close and current flows through the heater, thus warming the oven. When the proper upper limit of temperature is

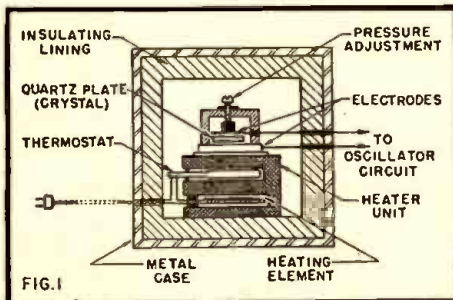

Fig. 1—A cross-section of the crystal oven.

reached, the contacts are opened and current ceases to flow. Thus the oven temperature undergoes a continuous heating and cooling through a range depending upon the design of the thermostat.

*Broadcast Engineer, ex WJLB-WLOU, Detroit, Mich.

The thermostat used with crystal ovens is either of the bi-metallic type or the mercury-column type. The latter is more commonly used, and is essentially a thermometer into which two contact wires have been fused. The construction of a crystal oven using a mercury-column thermostat is shown in Fig. 1. Temperature-control chambers and associated equipment are always provided in duplicate in broadcast practice. This provides a valuable safety factor, in that the auxiliary oven can be switched into the circuit at a moment's notice, thus precluding the necessity of going off the air due to failure of the main oven and resultant intolerable frequency drift. A frequency-control unit employing this principle is shown in Fig. 2.

Quartz-plate crystal resonators are not perfectly elastic, and the friction due to their vibration when in operation generates a certain amount of heat. This causes a rise in temperature when oscillation begins, with resultant frequency drift. This phenomenon cannot be entirely eliminated by the oven. However, to prevent the drift from being unduly large, three things may be done:

1. The oscillator may be kept operating at all times.
2. The oscillator circuit may be operated at a very low plate potential.
3. A low-temperature-coefficient crystal may be used.

The first expedient is usually too expensive, unless the station is off the air only a very few hours per day, but the last two are used in most all broadcast stations.

THE BUFFER AMPLIFIER

The stage of amplification immediately following the oscillator is known as a buffer. The voltage amplification of this amplifier is a secondary consideration; its primary purpose is to isolate the oscillator from the succeeding stages of R.F. amplification. This prevents any undesirable interaction which could cause frequency instability. This stage may be either Class A or biased to cut-off, but in any event no grid current must be permitted to flow. If an appreciable amount of grid current were drawn, there would be a varying load on the oscillator tube and resulting variations in frequency. When a properly-op-

erated buffer amplifier stage is employed, the oscillator works into its own load impedance of fixed value, supplying an R.F. voltage only to the buffer. In Fig. 2, the oscillator output is impedance-coupled to the buffer through a variable coupling condenser. Since no grid current flows, the grid-leak resistor must be large, so that the input impedance is as high as possible. The buffer output is also impedance-coupled. This presents a fairly constant load into which the tube may work and has a good transmission characteristic. The second amplifier which follows acts both as a voltage and power amplifier. It thus aids

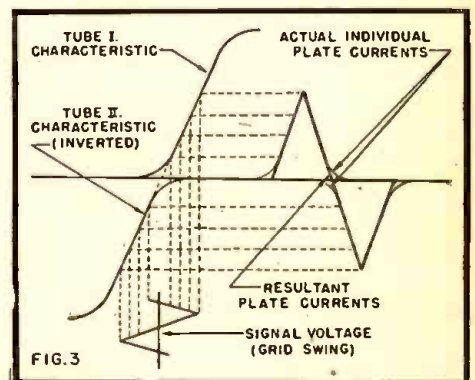

Fig. 3—How the push-pull tubes co-operate.

in providing additional isolation and also provides 7 watts of excitation to the R.F. amplifiers.

R.F. POWER AMPLIFIERS

In broadcast transmitters it is desirable to get the maximum power output with the least expenditure of power input. Class A amplifiers, while practically without distortion, are characterized by very low output and low efficiency. For this reason, Class B or Class C operation is preferred in R.F. power amplifiers. The essential difference between Class B and Class C amplifiers lies in the grid bias employed. In Class B operation, grid bias is close to cutoff, so that plate current flows only during approximately half of an electrical cycle when excitation is applied. With Class C operation, grid bias is appreciably greater than cutoff, such that plate current flows for much less than half of an electrical cycle when excitation is applied. Either circuit delivers much more power at higher efficiency than a similar Class A circuit. While Class A efficiency is on the order of 20% to 30%, Class B exhibits an efficiency of 60-70%, and that of Class C operation is 67-85%. In both Class B and Class C circuits, the control grid may be driven positive, and in Class C operation the grid may be driven so far positive that plate saturation occurs on positive grid swings.

Since the Class B R.F. amplifier is biased at or near cutoff, it operates at the lower bend of the I_p-E_g characteristic. When a signal voltage is impressed upon the grid, the resulting plate current variations resemble a half-wave rectified output. In other words, the plate current flows only

(Continued on page 377)

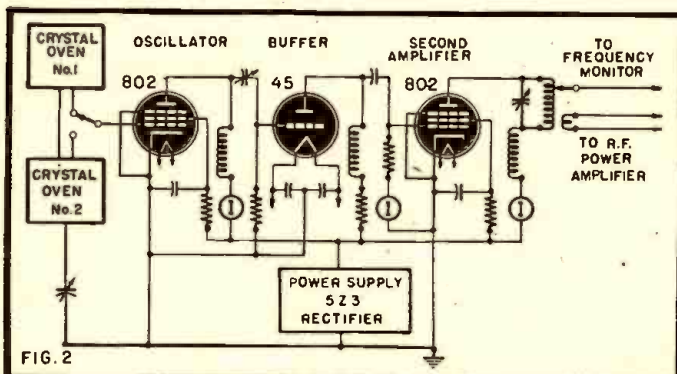

Fig. 2—The frequency control unit consists of a crystal, buffer or isolating amplifier and an additional stage of amplification.

HIGH FIDELITY

Extended frequency range is not the answer to the problem of excellent audio reproduction

By McMURDO SILVER



McMurdo Silver, high-fidelity sound pioneer.

WITH numerous panels of the Radio Technical Planning Board today engaged in examination of a multiplicity of subjects, the problems of post-war broadcast services, AM, FM and television, are receiving a considerable degree of attention. It is with the questions of band widths and frequency ranges required in musical reproduction that the writer is herein concerned. He desires to contribute certain views to the general and currently wide-spread thinking upon these subjects in the hope that the most reasonable and serviceable assignments may result for post-war use.

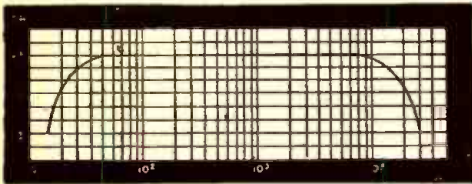

Fig. 1—Response curve of a hi-fi amplifier.

It is one thing to look at the presently usable radio frequency spectrum as a whole and, upon the basis of absolutely zero occupancy, to intelligently apportion segments thereof to the multitudinous services seeking accommodation. It is quite another thing indeed to take the same spectrum currently occupied by difficult-to-dislodge services, and in the face of occupants not easily (often not wisely) to be dislodged from their present frequencies, to patch up a sensible and workable whole in which every service gets an even and fair share of total available frequencies.

The standard broadcast band of 500 to 1600 Kc. is a good example of the difficulty. A shift of the services therein to new frequencies would be difficult indeed. Even a shift of band-widths within the present band is well-nigh impossible in a practicable sense.

Some might argue, possibly with justification, that all broadcasting should shift over from AM to FM, and consequently to higher, limited-range frequencies which would leave the essentially medium-long-distance frequencies from 500 to 1600 Kc. available to what will unquestionably be the greatly increased needs of commercial circuits bound to exist in a post-war period of increasingly active commerce.

Be that as it may, the broadcast band is today apportioned upon the basis of 10 Kc. per channel. This automatically limits modulation frequencies to a basic range of 5,000 cycles—a range quite inadequate for high-quality musical reproduction. Due to geographical and power separation of adjacent stations, it is possible for a powerful station to modulate up to 8,000 to 9,000 cycles with the expectation of rendering better service to nearby listeners for whom its signal will decisively over-ride distant and weaker

adjacent channel stations. Thus a distinctly improved service may today be rendered to a limited group of nearby listeners—presuming they are equipped with receivers, actually able to translate improved transmission into improved home entertainment.

HIGH FIDELITY—THEORY VS. FACT

Theory says that truly high-quality reproduction should extend from 30 up through 17,000 cycles, approximately. Such a range is a substantial impossibility in the standard broadcast band today. It may be approximated by widening receiver acceptance band-widths to the necessary 34 Kc., but this is almost uniformly unsatisfactory. The reason is that such a band-width automatically accepts three stations each spaced 10 Kcs. away from the next in the frequency spectrum. Even assuming the two undesired stations (one on each side of a desired powerful local station) to be so weak that their modulation as such causes no deleterious interference, the beating of the three 10 Kc.-spaced carriers will produce an annoying beat, or whistle, at 10 Kc. At once the thought occurs—chop out this whistle with a suitable filter. This solution

is simpler to envisage than to put into practice. A filter suitable for elimination of the very narrow band of frequencies lying immediately above, at, and below 10,000 cycles would be costly, complicated and cumbersome if in eliminating 10,000 cycles it does not also eliminate frequencies thereabout in a band so wide as to largely destroy the benefits sought through extended total frequency range. For example, a simple filter such as is found in the most expensive receivers will usually attenuate a band of possibly 9,000 through 12,000 to 14,000 cycles if it be effective enough to cut out 10,000-cycle carrier beats—and if it be

(Continued on page 380)

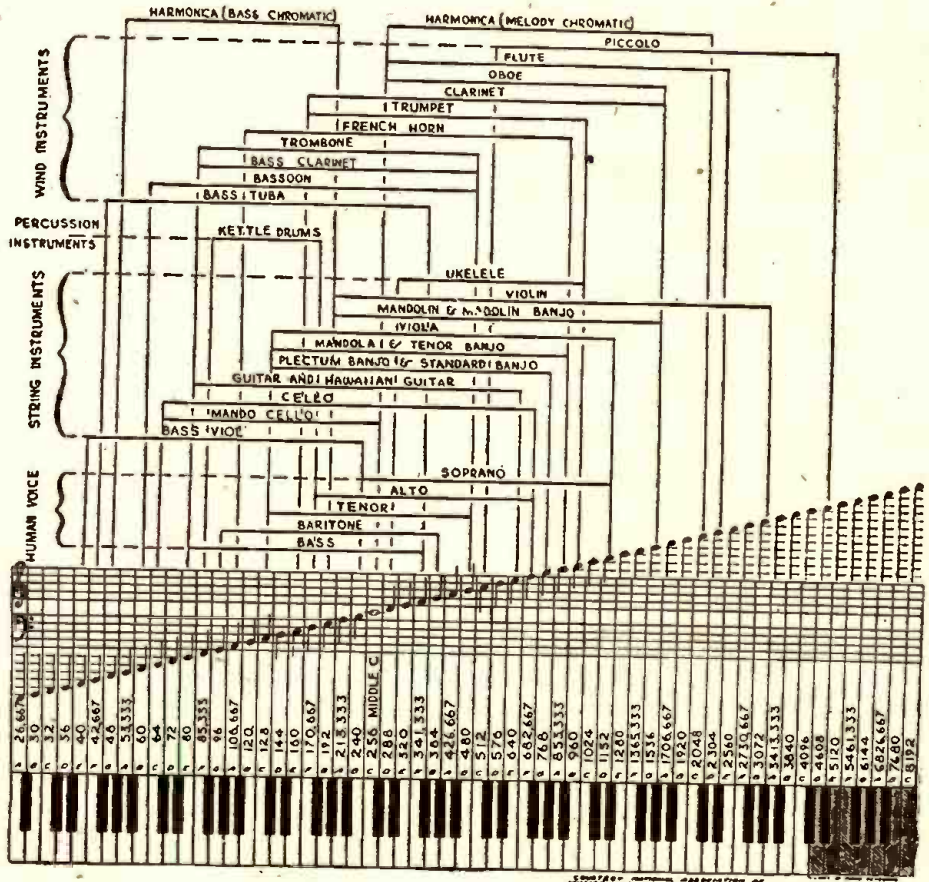

Fig. 2—The second harmonic of most musical instruments falls below the 8,000-cycle limit.

Courtesy Ghirardi's Radio Physics Course

CIRCUIT EQUALIZATION

By ROBERT SMITH

It is a well-known fact that the higher frequency sounds commonly encountered in voice and music are less intense than the lower frequency sounds, and that most of the sound energy is concentrated in

the lows. Referring to Fig. 1, note that at 3000 cycles the curve takes a sharp dip and that the higher frequency sounds have lower levels than those of lower frequency. This is also demonstrated by the curves in Fig. 2. Here, at "loud" level, we find a sharp dip downward at 3000 cycles. For the "soft" level the dip starts at about 350 cycles and for "normal" the break occurs near 600 cycles.

To over-ride noise in the transmitter or recording equipment, pre-emphasis circuit arrangements are desirable and necessary. These are used successfully in FM and movie work, as well as in television sound. The transmitting apparatus may be made to have a special pre-emphasis curve as shown in Fig. 3. The equipment linearity is altered by introduction of a pre-equalizer. In many cases, due to the method of transmission, noise reduction of the order of 10 db may be obtained.

The pre-emphasis and de-emphasis circuits are shown in Fig. 4. Using certain types of musical instruments, there may be a tendency to overload on the higher modulation frequencies, but this can be controlled by using a limiter amplifier between the speech amplifier and the input to the modulator. The method has been used successfully in recording, with vertical transcriptions, and recently has been used with 33 1/3 lateral transcriptions. As the maximum energy density occurs in the vicinity of about 300 cycles for music and around 500-700 cycles for speech, the pre-equalization characteristic should be made to start about 500-700 cycles if both speech and music are to be transmitted, with a limit of about 15 db equalization at 10,000 cycles.

The pre-emphasizer circuit arrangement to the transmitter may be connected between the pre-amplifier and modulator. The receiver de-emphasis circuit may be installed between detector and audio amplifier. The pre-emphasis and de-emphasis curves, as well as the flat over-all response curve for the system will be seen in Fig. 5.

In this form of equalization, where we deliberately introduce a rise in the response at the transmitter and correct for that accentuation of the "highs" at the receiver, there is still another form of equalization in common practice. We may find, for example, that a telephone line has a lowered capacitive reactance as the frequency rises. Accordingly, there is less transfer of power into the line at high frequencies than there is at low frequencies, giving us an uneven frequency response or non-linear characteristic. To correct this we may use some form of equalization.

Such a line may be used to link a studio to a transmitter, an amplifier to a load such as a loud-speaker or it may represent the mike to amplifier link. The input impedance for a short line is essentially capacitive because of the fact that the "loop resistance" is low and the inductance is of small value. We then have the equivalent circuit shown in Fig. 6. As the capacitive reactance decreases with frequency, more and more of the current tends to flow in C than in the higher impedance circuit consisting of R and Z_L in series. R is representative of the loop resistance of the line. (If each conductor of the transmission line has 100 ohms resistance the "loop resistance" of the two conductors in series would be 200 ohms.) This would be the resistance measured at the input terminals with the far end or load shorted, assuming a high leakage resistance between conductors, which usually is the case. The leakage between conductors may be as high as 100 megohms per mile in typical cables used in telephone work.

To compensate the line or "equalize" it, we may use a simple parallel coil, as shown in Fig. 7. The inductance has a low impedance at low audio frequencies, and introduces a loss at the lower frequencies. This compensates for the tendency of the lows to be stronger than the highs—by introducing an inverse characteristic. In other words, the effect of the coil is balanced against the effect of the condenser. The capacitive input circuit is made up, in this case, not only of the input capacitance of the line, which in Fig. 7 is C₂, but also of an additional input capacity due to the equalizer, C₁. The resonant circuit L-C₁ is made to resonate at about 12,000 cycles if the maximum transmission limit is to be about 10,000 cycles. In a typical installation, where the upper audio limit is 8000 cycles per second, as in movie work, the resonant circuit may have a frequency of 8500 cycles. Values of L and C are usually adjustable so that a transmission characteristic suitable to meet the particular requirements of the circuit may be worked out. A typical set-up is shown in Fig. 8. Elements of the equalizer are variable.

An equalizing amplifier developed by E.G. Cook, a communications engineer, is shown in Fig. 9. The amplifier is a high-level type and may be used as a sound effects equalizer, recorder cutting head driver, playback equalizer or loud-speaker equalizer amplifier. It can be used to build up or lower the high frequency end of the audio spectrum in calibrated steps at a known frequency, and any specified low frequency may be controlled in the same way. The amplifier uses four tubes. The 7F7 tubes are dual

(Continued on page 365)

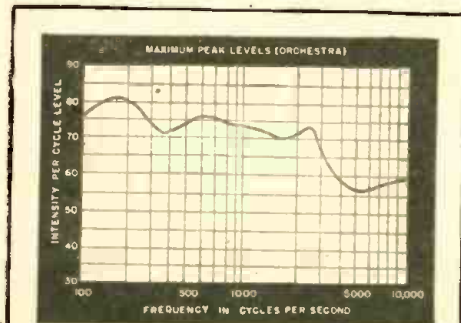

FIG. 1

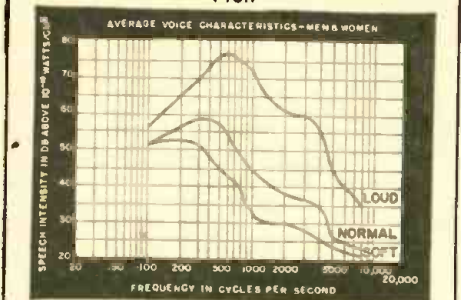

FIG. 2

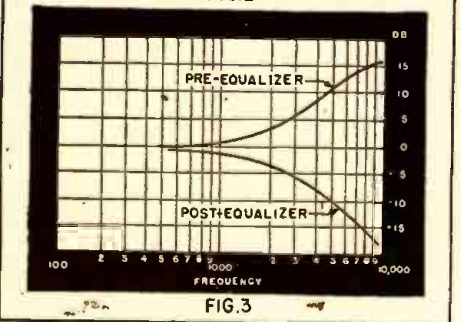

FIG. 3

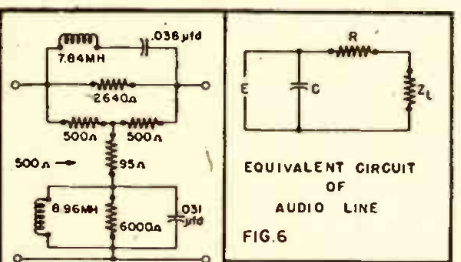

FIG. 4

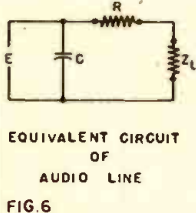

FIG. 6

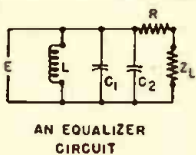

FIG. 7

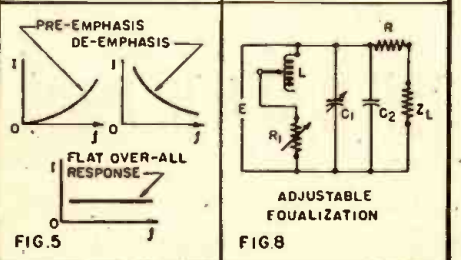

FIG. 5

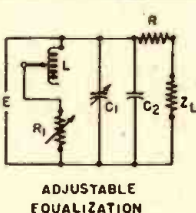

FIG. 8

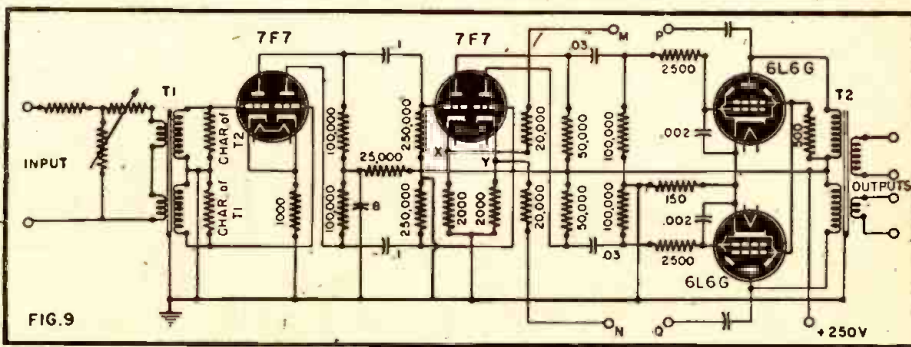

FIG. 9

Grounded-Grid Amplifiers

By **STUART T. BLACK**

THE grounded grid amplifier is an extremely useful type. The circuit diagram of a typical stage is shown in Fig. 1. A signal voltage E is applied to the primary of the R.F. transformer and causes a signal current in flow in L_1 . The field developed about L_1 links with L_2 and induces a secondary voltage which is stepped up by resonant circuit action in L_2 - C_2 . This R.F. voltage acts in series with the grid-cathode of the amplifier tube and thus controls the grid-to-cathode potential. As the grid voltage varies in accordance with the R.F. signal the plate current of the tube similarly changes and the varying signal current flowing in the primary circuit of T_2 , develops a signal voltage across C_3 and L_3 . The triode tube does not oscillate, or regenerate because the grid is grounded and the grid-plate capacity of the tube is not effective in aiding oscillation. The noise level using a triode is lower than that obtained when a screen grid tube is used.

In a conventional triode tube circuit we have three capacitances: the grid-cathode, grid-plate and plate-cathode capacities.

This is shown in Fig. 2. Note that the effect of the grid-plate capacitance is to increase the input capacitance of the tube since the plate has capacity to ground or the cathode, in shunt with the input capacitance between grid and cathode. The net input capacity of the tube between grid and cathode is in shunt with the input circuit and its effect at high frequencies is great. A high-frequency circuit may be so detuned that it won't work due to the high minimum capacity.

Now, let's see what happens when we ground the amplifier tube grid. The equivalent circuit appears in Fig. 3. Note that here, while the grid-cathode capacity remains the same, we have almost no grid-plate capacity and no plate-capacity shunt effect back on the grid circuit, so that the input capacity effectively is reduced to a very low value. Of course, there may be some capacity between the cathode and heater, but it can be kept to a low value. It would be possible to increase the impedance of the heater circuit, if desirable, by inserting chokes, but usually this is not done. Also observe another interesting thing. The plate-cathode capacity of the tube using the grounded grid arrangement is not in series with the grid-plate capacity. This means that the input capacity of the tube is not in parallel with the load through that grid-plate capacity, and that the shunt capacity across the load is also reduced—in addition to the reduction in the input capacity.

The signal voltage acts in series with the cathode circuit, causing the signal current and load current in input and output circuits to be in phase. Referring to Fig. 1, assume that the input voltage is such that, starting from zero and increasing in positive values we have the gradual development of a positive half of a sine wave. As the R.F. voltage rises, the potential difference between the grid and cathode is increased and the grid becomes more negative with reference to the cathode. The electrons between the cathode and plate and the electronic current in the load, therefore, must be decreased in value instantaneously because of the increase of negative potential of the grid. The plate current goes down. As the input R.F. voltage between points 1 and 2 reaches zero and goes through the negative half of the R.F. cycle, point 1 is made negative with reference to the grid and increases in

negative value, so that the grid-cathode potential in effect becomes less negative and the plate current rises. Remember that we are talking about a signal voltage acting in the cathode circuit. There is a shunt capacity across the bias, so that the bias source has no R.F. impedance.

Assuming the load is an R.F. impedance,

of the tube. Increasing the voltage subtracted, allowing thereby a rise in load voltage, means lowered plate potential. Now compare the phase relations of the inverted tube or grounded grid with the regular triode type tube. Note that, in the grounded grid, the load signal current is out of phase with the input voltage and that in the regular triode it is in phase with the grid driving voltage.

Fig. 5-a shows the relations between in-

Fig. 1—Typical circuit of grounded-grid amplifier. Fig. 2—Conventional triode, equivalent circuit. Fig. 3—An equivalent circuit of the grounded-grid amplifier. Fig. 4—Standard amplifier for comparison. Fig. 5—Grounded-grid and standard amplifier action compared.

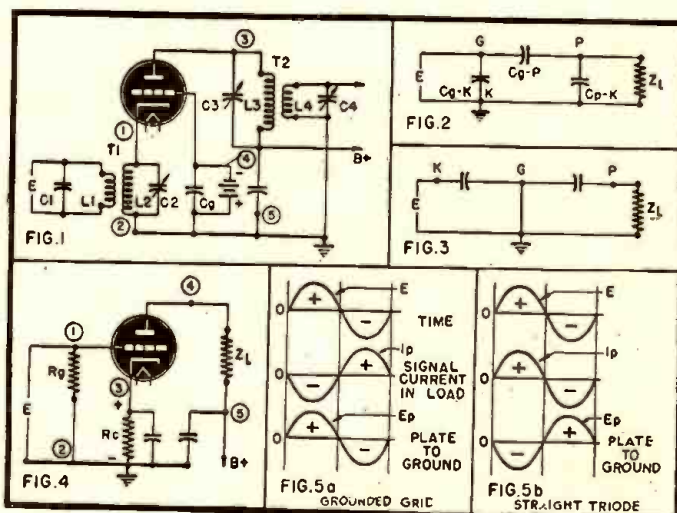

as the signal current in that load rises there is an increased voltage drop across the load which subtracts from the plate supply potential and the plate voltage must go down as the plate current rises and the plate-cathode resistance of the tube decreases in value. The voltage directly across the load must vary as the current through the load and is in phase with the load current. The voltage between plate and ground must go down as the drop in the load rises in value. Thus, it is seen that as the voltage rises from zero to a maximum positive value between points 1 and 2, the voltage between points 3 and 5 goes up, and as the voltage between 1 and 2 is reduced in value, so is the voltage between 3 and 5.

Now let's see what happens in the ordinary triode amplifier. The circuit is shown in Fig. 4. Assume at the beginning of the cycle that we have a positive voltage between the cathode of the tube and ground. This makes the grid negative with reference to the cathode. Also, bear in mind that the grid-cathode potential is what controls the number of electrons reaching the plate (as well as the plate potential and other factors). We have a steady current when no input signal voltage E is applied. If we assume that gradually point 1 is made positive with reference to point 2 by the input signal, the net grid-cathode potential will be changed from the normal or resting value to a less negative value. There will be a rise in the number of electrons in R_c , the plate-cathode space and Z_L . The increase in electronic current through Z_L will produce a voltage drop across the load which will be in phase with the input voltage. The voltage between the plate and ground, however, will decrease in value and will be 180 degrees out of phase with the input signal, because the rise across the load subtracts from the plate supply voltage to give the net voltage on the plate

put voltage, plate current and plate voltage in the grounded grid amplifier as compared with those in the conventional triode amplifier shown in Fig. 5-b.

The grounded-grid amplifier is something new and unusual, but it has already been used in circuits where its freedom from oscillation is an advantage. It's well worth while to keep your eyes on some of these strange circuits—you never know what you may be able to do with them some day!

NEW ALLOCATIONS O. K. SAYS TELEVISORS HEAD

SATISFACTION with the FCC television allocation was voiced last month by J. R. Poppo, president of Television Broadcasters Association. In an official statement, he declared:

"The Television Broadcasters Association, Inc., is pleased to learn that the Federal Communications Commission has rendered a decision favoring continuance of commercial television in the portion of spectrum currently used by television broadcasters."

Acclaiming the Commission's stand against abandoning the present bands until a wide-channel system in the ultra-highs could be developed, he said:

"TBA supports the view of the Commission that the higher frequencies need further experimentation. It is noted that in taking this position the FCC has not assigned any specific channels in the ultra-high frequency band for commercial television. Thus the Commission has taken the progressive view and supports immediate commercialization of this new industry in that portion of the spectrum recommended by industry leaders."

INTERCOMMUNICATORS

By M. N. BEITMAN*

INTER-COMMUNICATORS have gained greatly in importance since the outbreak of global war. Extensive use is made of intercommunicators on bombers and naval vessels. Here, quick direct two-point conversation permits exchange of vital information at an instant's notice. In offices and factories, inter-communication systems supplement the telephone, reduce the burden at the switchboard, and eliminate delays and errors often caused by the telephone operator. On a moment's notice, a manager of a plant can ask the shipping clerk about a certain order, a Mr. Brown can be paged anywhere in the building, or the president and the manager can have a private conference with the aid of an inter-communication system.

SOME BASIC PRINCIPLES

When someone, perhaps 20 years ago, placed the loud-speaker some distance away from an audio amplifier and microphone, the first inter-communicator was born. The loud-speaker could be located in a room different from the one containing the amplifier and mike. By using a second system and placing the equipment in *reverse* to the first system, a two-way conversation could be carried on. If both systems were left in the operating position, a loud howl would develop because of the electro-acoustic feedback. Therefore, means were provided for breaking the circuit of each system at some point. The individuals using the equipment controlled these switches as the conversation shifted back and forth between the two points.

The realization that a magnetic or a P.M. speaker could serve as a suitable microphone for voice frequencies, made a great change in the design of inter-communicators. Assume you have a simple audio amplifier (see the schematic, Fig. 1) incorporating a suitable input transformer, T_1 , to match the P.M. speaker's voice coil impedance to the input grid, and a second transformer, T_2 , in the output circuit to match the 50L6 tube to this same type of speaker. Also, assume you have *two* identical P.M. speakers. Call these speakers

Speaker 1 and Speaker 2. By connecting one speaker to the input of the amplifier, and the other speaker to the output, conversation may proceed from Speaker 1 (used as a mike, at this time) to Speaker 2. Speaker 1 may be in one room with the amplifier, while Speaker 2 is connected with a long cable and is placed in another room. By employing a suitable switch, the connections of Speaker 1 and Speaker 2 could be reversed. Conversation can now originate at Speaker 2 (used as a mike), and be reproduced from Speaker 1. The physical position (placement) of the speakers may remain the same. The controlling switch for the speaker-connections is usually included in the cabinet of the amplifier.

The natural outgrowth from the basic system described, is the *master selective* system. One amplifier unit with its speaker is still used at one location, but instead of

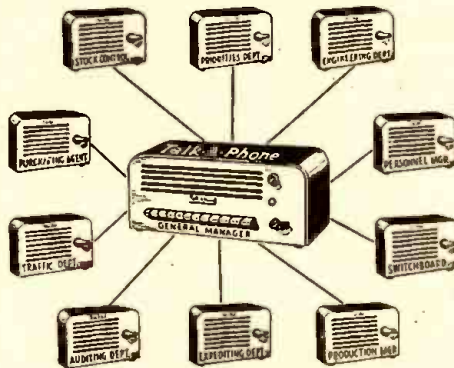

Fig. 2—A typical intercommunicator circuit.

one speaker at some other single point, several speakers are used and each is located at a different desk, or room, or station. Fig. 2 is a typical hook-up. In the commercial units, facilities are provided for ten such sub-stations, but any number less than ten can be used. Such a system permits private two-way communication between the amplifier (known as *master*) station and any of the sub-stations. The master station can call all sub-stations simul-

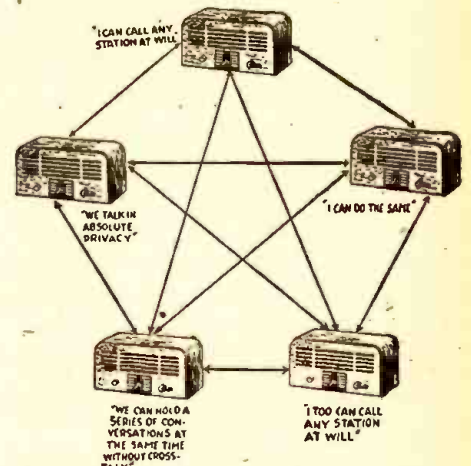

Fig. 3—This circuit permits the most efficient use of intercommunication facilities.

taneously if need for this operation arises. The sub-stations can answer and call the master station, but cannot call one another. It is possible to place the units as far as 3,000 feet apart from each other, but shorter distances are recommended. The person operating the master unit, of course, must control the "talk-listen" switch.

A complete system may be made up of master stations only to permit great freedom and versatility of operation. For example, in a system made up of ten such master stations five two-way private conversations can be held simultaneously without interference or cross-talk. (See Fig. 3). Each station can call any other regardless of whether the station being called has the power "on" or not.

It is possible to combine master stations, sub-stations, and special booster units to serve special requirements. Certain applications may require the master stations to have facilities to call any other master or any sub-station, but the sub-station may not need to originate calls. Headphones may be incorporated for privacy of conversation. A booster unit (high-powered amplifier) may be used in connection with a sub-station for louder reproduction and paging.

* Supreme Publications, Chicago, Ill.

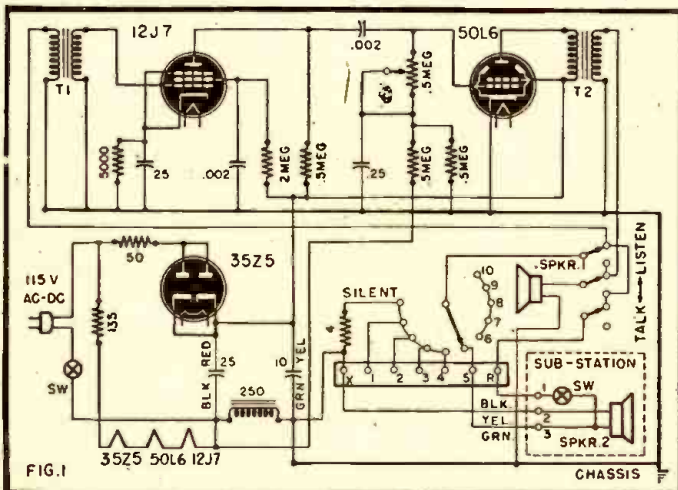

Fig. 1—A standard intercommunicator. The master station can communicate with a number of installations at some distance.

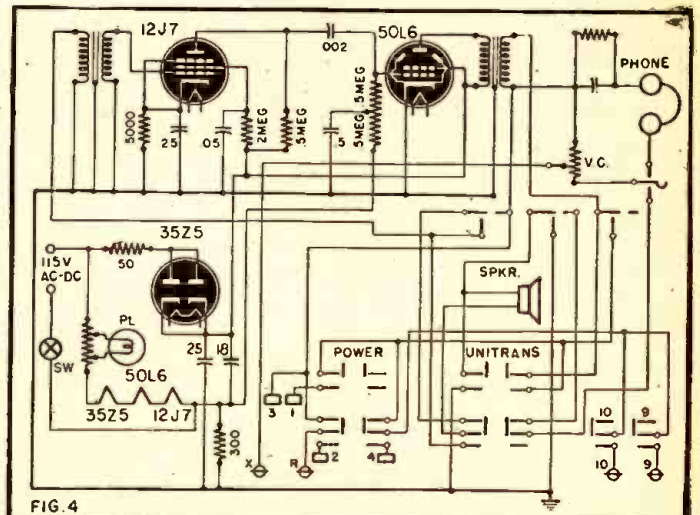

Fig. 4—The super-selective circuit makes any station master, and provides multiple communication between separate pairs of stations.

Plane Temperature Electron Control

By R. H. WHEMPNER*

CONTROLLING temperatures in a house is one thing, but controlling temperatures in an airplane is quite another. A home, unless a cyclone comes along, stays put and thus outside temperature fluctuates only gradually. But an airplane moves from one temperature condition to another in a matter of seconds, and sometimes these changes are as much as 50 degrees or more.

Post-war air travelers will depend upon tiny coils of wire and electron tubes to keep warm while roaring through the stratosphere. The coils, like fingers reaching ahead of the plane, will anticipate temperature requirements and deliver more or less heat even before passengers realize what's going on in the outside air only a few inches away.

Completely automatic, the device goes under the lengthy name of the Electronic Cabin Temperature Control System and has been in test service on several airlines and combat use on Army transport ships for some time.

The new control system is a package unit weighing slightly under eight pounds, and is designed to hold automatically any cabin temperature selected by the pilot. To passengers this means perfect comfort conditions under all kinds of flying weather, and to pilots and stewards it means an end to passenger complaints and the nuisance of constantly making adjustments of manual controls.

Connected to the master control switch in the cockpit, the new control system is automatically turned on when the pilot starts the engines. However, unless heat is required immediately, the heating system remains inoperative until outside temperatures fall to a point requiring the addition of heat for passenger comfort. At this point, without any attention from the pilot, the heating system starts delivering heat to the cabin in the exact amounts needed to maintain the pre-selected temperature—usually 70 degrees.

The system includes an outside air compensator. This is a small coil of wire installed in the duct bringing outside air into the plane's heaters. Temperature fluctuations change the electrical resistance of the

Size of the control unit is shown by the photograph at the right.

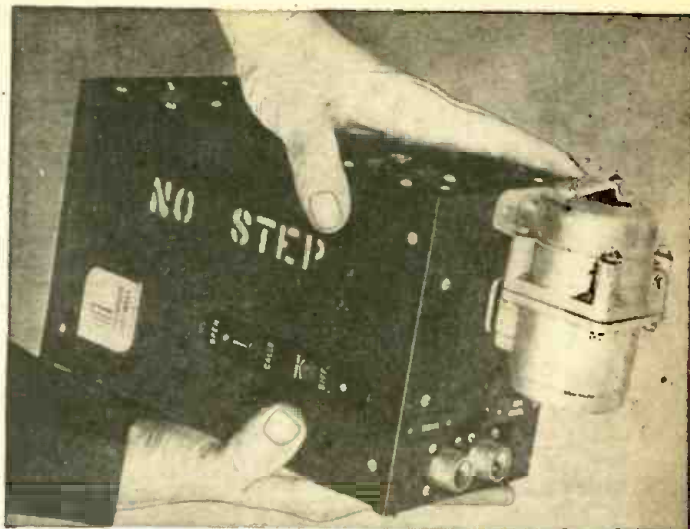

wire. Although this change is only slight, it can easily be measured through electron tubes. Serving as the brains of the system, the tubes learn from the coil that the outside air is colder or warmer, as the case may be, and send electrical messages to a motor which opens or closes a mixing damper and thus proportions the amounts of outside air with heated air from the plane's heaters to produce the exact temperature required.

The system also includes a cabinstat, which is another coil of wire mounted in the cabin and serving the same function as a thermostat in a house. This, too, interprets temperatures and sends messages to the electron tubes which, getting signals from both coils, positions the mixing damper to maintain the selected inside temperature. The latter is determined by a small dial mounted in the cockpit and can be adjusted by the pilot.

If a plane takes off while ground temperatures are at 70 degrees, no cabin heat is required, but as it climbs to altitude, outside temperatures usually take a nose dive. The little outside compensator notices this drop immediately and tells the tubes which, in turn, start delivery of heat to the cabin. The passengers are not conscious of the outside change because of the reservoir of heat in the cabin. But before this heat is lost to the outside, making the passengers uncomfortable, heat is coming into the cabin in the exact proportion needed to maintain a constant and comfortable temperature. The reverse is true when the plane moves into warmer temperatures, because while the inside cabinstat calls for heat, the outside coil knows that less heat will be required and so less heat is delivered.

CHECKER FOR MINES

FOR checking the electrical circuit continuity of mines the Army uses thousands of small, portable ohmmeters. Every booby trap, every land mine that goes off to do its deadly work must first be planted. When a land mine is planted it must be checked to see that it will go off. This is done by passing through the electrical circuit of the mine a tiny current—not enough to set it off, but enough to prove the circuit continuity.

A new type of portable instrument which Westinghouse had almost ready for peaceful pursuits at the time of the Pearl Harbor attack was dusted off and found to be just the ticket. This tiny instrument is about the size of a cake of laundry soap, the overall dimensions being only three by four by one and one-half inches. Although the molded case must also contain the dry cell, the instrument could readily slip into a side coat pocket. For all its small size it has excellent accuracy—two per cent—which is more than is needed for the mine checking chore. Accuracy can be doubled for work that demands it by addition of internal shielding for which provision is made.

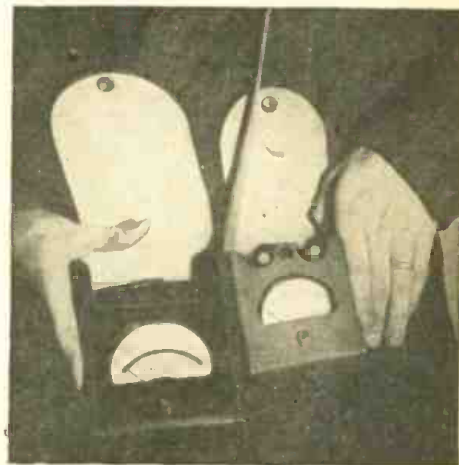

As a convenience to radio operators now in the military service or employed in war industries distant from their homes, the FCC has adopted Order No. 124 extending for a period of one year the time within which applications for renewal filed prior to December 31, 1945, may be accepted. The Order is not to be construed as authorizing continued operation under the terms of any radio operator's license after its expiration date.

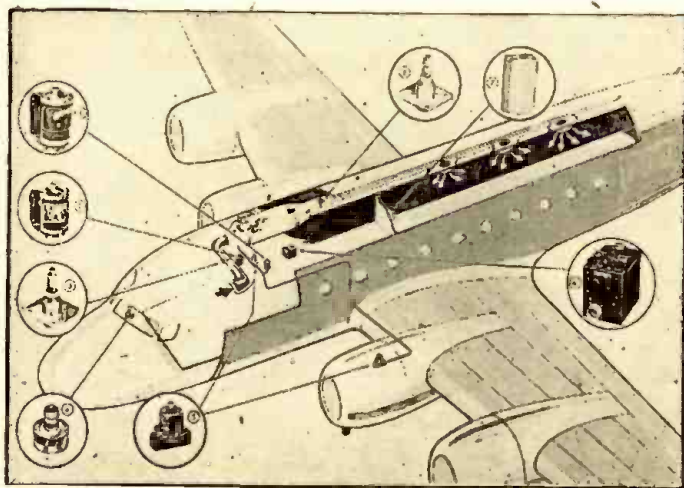

Nos. 1 and 5—Safety switches which cut off gas supply to heaters if fuel line breaks. 2—Air Ram switch. 3 and 8—Outside air compensators which turn on the heaters. 4—Control switch. 6—Amplifier. 7—Cabinstat, to be mounted in the area whose temperature is to be controlled.

A HEAT-VARIABLE RESISTOR

THE thermistor is a special kind of resistor. It is made of a mixture of metallic oxides of that class of materials known as semi-conductors, pressed into rods and extruded into rods, or formed into tiny beads. Their "special" feature of the thermistor is its high negative temperature coefficient of resistance. In other words, its electrical resistance decreases rapidly as temperature is increased, and conversely, increases as temperature is lowered.

Thermistors and their special characteristics may be used in electrical circuits wherever temperature changes can be produced. There are three basic ways of varying the temperature; externally, directly, and indirectly. If the ambient temperature rises, the resistance falls accordingly. If a current is passed through a thermistor, heat is produced internally and directly, the temperature rises and the resistance lowers. If a small coil of wire is placed closely around the thermistor and current passed through it, heat produced by the coil warms the thermistor and lowers its resistance. The unit is then said to be indirectly heated. Thus by suitable electrical connections, changes in the thermistor resistance may be used for measurement or for control of ambient or circuit conditions as desired.

One of the older types of thermistors, the 1C, which may be known to some electronic engineers, typifies the operation of the 30 to 40 types now in manufacture. This is a directly-heated type of thermistor and consists of a minute bead of oxides suspended on fine wires and enclosed in a nitrogen-filled glass bulb with two wire terminals. This assembly is further encased in an insulating tube with metal contacts on the ends, much like a fuse housing. The overall length of the completed unit is approximately 15/16 inches, and the outside diameter is about 1/4 inch.

A 1C thermistor, at room temperature, has a resistance of approximately 50,000 ohms. As current flows through the oxide bead, the unit is heated and its resistance decreases. To demonstrate the extent of the decrease brought about by the resistance versus power characteristics of the unit, let us raise the power input to 18 milliwatts. At this point the resistance of the unit will be approximately 18,000 ohms, showing a decrease of approximately 32,000 ohms. When 100 milliwatts is applied, the resistance will be approximately 500 ohms.

The thermistor will trace and retrace the characteristics here indicated without appreciable deviation over an indefinitely long life. Laboratory tests have indicated that the thermistor's characteristics are stable and substantially unchanged after more than a half-million heating cycles. Other thermistors have been studied and found to yield equally good life performance.

The thermal and electrical characteristics of externally, directly, and indirectly-heated thermistors suggest a vast number of possible circuit applications. New thermistors are continually being developed for use in amplifiers, oscillators, voltage regulators and volume limiters. In these devices they serve a variety of functions such as stabilization, temperature compensation or time delay.

When placed in the proper bridge circuits, thermistors may be used as flow meters, as vacuum gauges, or, in general, to measure physical quantities dependent upon the flow of thermal energy from a

hot body. When used as resistance thermometers, precision greater than that obtainable with thermocouples is possible, or the same precision can be obtained with simpler equipment. Temperature regulation can be accomplished with thermistors and relatively simple associated equipment. Frequently this results in lower production costs.

As a temperature compensator, the thermistor may be used to compensate for

changes in resistance due to ambient temperature variations in circuits having a positive coefficient of resistance.

As variable resistance devices, thermistors have important use in automatic transmission-regulating networks.

Standard relays, subject to false operation caused by high voltage surges, have been converted into slow-acting devices by putting directly heated thermistors in series with their windings.

Array of different types of Western Electric Thermistors. Photo at the right includes the pressed-disc, the bead and extruded-rod type. Essential component of all is a semi-conducting oxide with a large negative temperature coefficient of resistivity. The biggest Thermistor in the center contains a special network to counteract outside temperature changes.

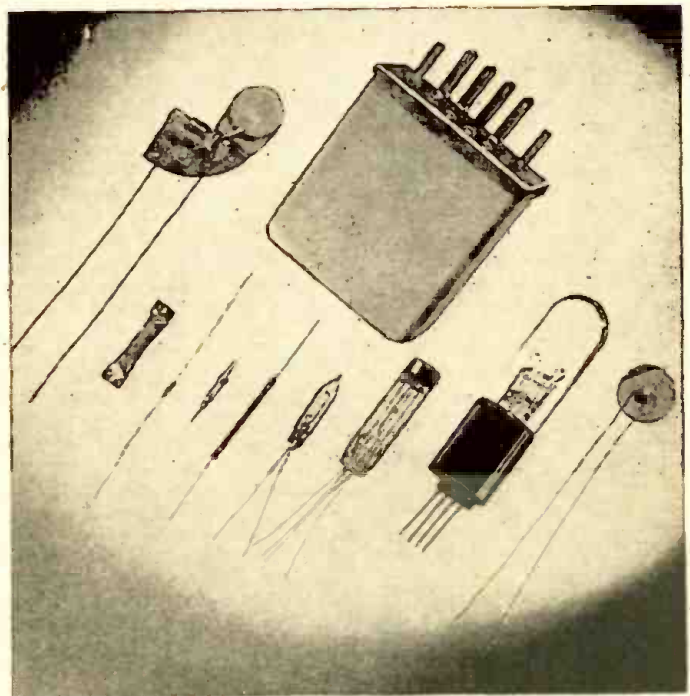

STANDARDIZED H-F HEATERS

AN essential step has been taken in the development of induction and dielectric heating. The needs for generators of high-frequency power have crystallized to the point that production-line type standard units have been created. It is no longer necessary to have a generator designed to serve a given purpose. Most needs can be served well—and with all the advantages of standardized stock units—by the range of powers and frequencies available in the accepted range of units. A group of ready-made heaters has just been made available by Westinghouse. The smallest size unit has an output of but 1 kw., the largest 200 kw. Between them lie units of 2, 5, 10, 20, 50 and 100 kw. Each size is available for several frequencies over some portion of the 200 to 500 kilocycle, and 2 to 30 megacycle bands.

The acceptance of high-frequency oscillators by industrial engineers has undoubtedly been delayed by the maze of tubes, transformers, connections, and

many mysterious appurtenances that seemed consonant with "radio" equipment. The designers have done much to dispel this psychological hurdle by providing generators that not only look simple, but are simple to operate. These stock units are completely self-contained. They require only electrical connection to a 60-cycle power source of 220 or 440 volts. Housed in a single cabinet, itself the handiwork of industrial artists, are the oscillator, power supply, blower, and switches.

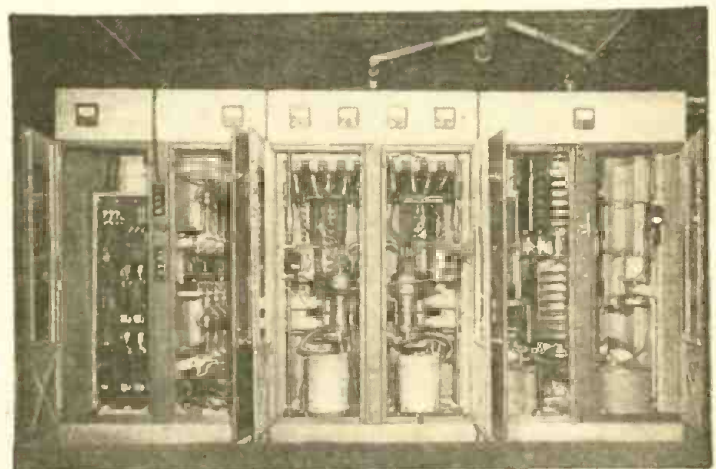

SPEECH AMPLIFIER

PART VI—PUSH-PULL AND PHASE INVERSION

By ROBERT F. SCOTT

PUSH-PULL stages are often used in a speech amplifier either to supply the necessary voltage to drive an output stage or to reduce certain types of distortion. One of the most simple methods of producing the 180-degree out-of-phase voltage for the grids of the push-pull stage is to employ a transformer with a split secondary winding. This is highly efficient but does not always possess desirable frequency response characteristics. A transformer with good response characteristics is costly, almost unobtainable in these times, bulky and inclined to pick up hum from the magnetic fields around the power transformer and filter chokes.

Another method known as "phase inversion" may be used.

The phase inverter is a simple, economical method of replacing the push-pull inverter transformer. The fidelity of this circuit is often better than can be obtained from the most costly of audio transformers. It is common to employ resistance coupling in a speech amplifier and phase inversion enables it to be applied throughout the entire amplifier. One possible disadvantage of phase inversion is that in most of the circuits the inverter tube does not furnish much gain. This is due to the use of degeneration.

The first type of inverter circuit to be discussed is the "Cathode Loaded" type. Let us picture the average single-ended resistance-coupled amplifier stage. In this case the gain of the stage is equal to $\mu \times R_L / R_L + R_p$ and the voltage applied to the following grid is 180 degrees out-of-phase with the input voltage of the first stage. This scheme is suitable for exciting a following single-ended stage but could not possibly be used to excite a push-pull stage.

Suppose we should split the output load of our amplifier tube so that half of the load would appear in the cathode of the tube. Will it work? Certainly it will. The output voltage will be equal to the plate current change times the value of the load resistor. Let us take a look at Fig. 1 where we see one-half of the tube load inserted in the cathode circuit between the cathode biasing resistor and the ground. This load resistor we choose to call R_{CL} while we call the load in the plate circuit R_{PL} .

The grid leak is returned to the junction of the grid-bias resistor and the cathode loading resistor. This is done to maintain proper potential difference between the grid and cathode. The grid-circuit resistance is the sum of R_{G1} and R_{CL} . Hence, R_{CL} IS COMMON TO BOTH THE INPUT AND OUTPUT of the inverter tube. The output voltage is proportional to the plate current changes and since it is necessary to supply equal voltages to both grids of the push-pull stage the values of the loading resistors should be equal.

The equivalent circuit for the cathode-loaded inverter is shown in Fig. 2. Since a portion of the load appears in both the input and output circuits; degenerative feedback is introduced into the circuit, with a reduction in the gain and an increase in

the "effective plate resistance." The gain can no longer be calculated from the equation for resistance coupled amplifiers but must be computed from the equation.

Gain (with feedback) = $(2\mu R / R(\mu + 2) R_p)$ where μ = amplification factor of the tube, R_p = plate resistance, and $R = R_{PL} = R_{CL}$.

In this case the gain of the inverter will never exceed 2. This is due to the fact that the gain with feedback varies inversely with the amount of feed-back voltage. It has been established that when the percentage of feed-back voltage is large; the over-all gain of the stage will be independent of the amplification factor of the tube.

Several types of distortion are likely to be generated within the vacuum-tube amplifier stage. One advantage of inverse feedback is that it tends to reduce the percentage of distortion present. Let us assume that D represents the percentage of distortion present in a stage having a voltage gain of A without feedback. Now if B is taken as the feedback factor, when feedback is introduced into the circuit, we find that although distortion is still present in the circuit it will have a value of D'. This new value is found to be equal to $D / (1 + BA)$.

This shows that the reduction in distortion is dependent upon the factor BA. Since, in the cathode loaded inverter, the feedback factor is a fixed value of 50%, the only other possible method of decreasing the distortion is by increasing the value of A or by using a tube of higher gain. (Proper application of feedback reduces distortion in the same proportion as the amplifier gain is reduced.) Feedback not only improves the frequency response by a

reduction of distortion but is equally effective in reducing the hum which may be picked up by the stage to which the feedback is applied.

We have mentioned that the gain of such a stage never exceeds 2. This factor is taken from the ratio of the input voltage to the voltage measured across the grids of the push-pull tubes. Assuming a gain of 1.9 for the inverter, the gain from the grid of the inverter to either of the push-pull grids will be only .95.

Although the gain of this type of inverter is comparatively low, the voltage possible at the output is quite capable of exciting almost any combination of output tubes. The maximum grid-to-grid voltage is equal to approximately 20% of the plate supply voltage.

A circuit for phase inversion which has been popular for a number of years is the "Tapped Output" inverter. This is also one of the most criticized. Perhaps this criticism is due to a misunderstanding of the circuit. Two tubes are employed to give the proper phase changing and amplification. These tubes may be identical triodes or one of the dual triode types as the 6Z7, 6N7, 6A6, or the 6SC7. The latter tube is especially designed for phase inverter service. The circuit is illustrated in Fig. 3 where T_1 and T_2 may be separate triodes or the two sections of a dual triode.

There is practically no degeneration in this circuit. The gain is equal to $\mu \times R_1 / R_L + R_p$ so the use of a high mu triode will result in a higher over-all gain for the inverter stage. T_1 operates as a conventional resistance coupled amplifier working into the grid of T_2 . The output of T_1 appears across the grid resistor of T_2 , which is composed of R_3 and R_4 in series. The grid of T_2 is tapped to this network at the junction of R_3 and R_4 . Any voltage tapped at

(Continued on page 378)

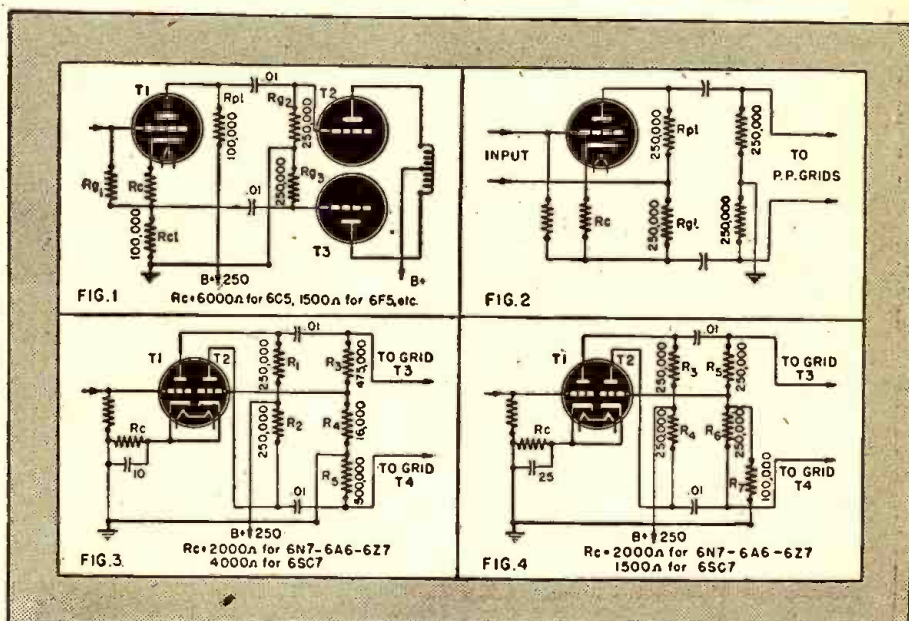

Fig. 1—A cathode-loaded or "Kangaroo" inverter. Fig. 2—Equivalent circuit for same. Fig. 3—An efficient amplifier-inverter stage. Fig. 4—The so-called "self-balanced" inverter.

TWO COMPACT SETS

By G. L. KEIRSTAD

THE circuit sketched is a champion. Tuned to any one of the four Toronto broadcast stations or WGR or WBEN, Buffalo, one 6A8-GT will drive the 3-inch speaker at any time of the day, and will pick up a few more, including WHN, New York, in the evening. Volume is quite adequate for a personal radio—all one should use in a hotel to avoid disturbing guests in adjoining rooms.

The circuit makes any explanation almost unnecessary. The inner two grids of the 6A8-GT are used as grid and plate of a grid-leak detector, the output of which is transformer-coupled to the control grid as an audio stage. Exceptional stability is an outstanding feature of the circuit. Good R.F. filtering and the fact that but two turns of regeneration are used account for this. The latter accomplishes another useful purpose—it permits operation of the regeneration control at near full setting, insuring near-maximum plate current and consequently improved power output for speaker operation. Tuning squeals are practically eliminated.

The audio stage is quite conventional. Ordinarily one wouldn't need the .0008 condenser across the transformer secondary if it's a reasonably good one. I had two from an ancient Marconi—both with shot primaries, I heated one until the primary would push out and rewound it from the other secondary. Building backwards in this fashion, it was hard to get enough turns on the primary to keep the turns ratio low, so the condenser eliminates a slight tendency to distort on loud highs.

As for power supply, almost any type will do—I used a 6K7-G for a rectifier. Either a capacity-resistance or capacity-inductance filter is satisfactory the latter giving slightly better speaker volume. Hum was non-existent in either case. The choke was a tiny output transformer that I could never match with anything. Note that when resistive filter was used the bleeder was placed at the cathode rather than the B-plus side

to avoid the considerable voltage drop resulting from forcing this surplus through the filter.

The rather large antenna coupling condenser is necessary for speaker operation as is an antenna of approximately 40 feet overall length. For headphone operation, selectivity may be increased by reducing antenna length or using a small coupling condenser.

A coil of 90 turns of No. 28 enamel wire, close-wound on a 1½-inch form, will prove suitable, as will any ready-wound broadcast coil. The tap for regeneration on my set was taken off at only two turns from the ground end. While I would not like to try to explain how, the action of the set leads me to believe that there is some further



Layout of the three-tube broadcast receiver.

regenerative effect due to coupling inside the multi-grid tube (page Mr. Martin).

The set is at present on a cigar-box bread-board, but I intend shortly to put it in a "cabinet" similar to the set shown in the photographs. This is the receiver I carry in my grip, and really is a honey—2 6SF5's and a 32L7. A circuit diagram is appended in case anyone should be interested, though there is absolutely no departure from the orthodox circuits—which by this time should be known to everybody—in this receiver.

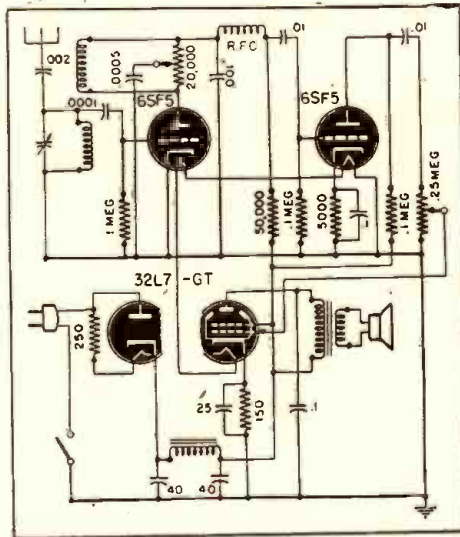

A compact three-tube for travellers' use.

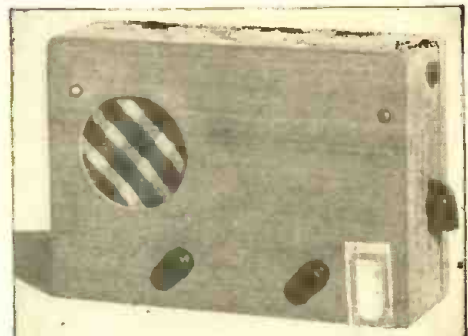

The set looks well in its cigar-box cabinet.

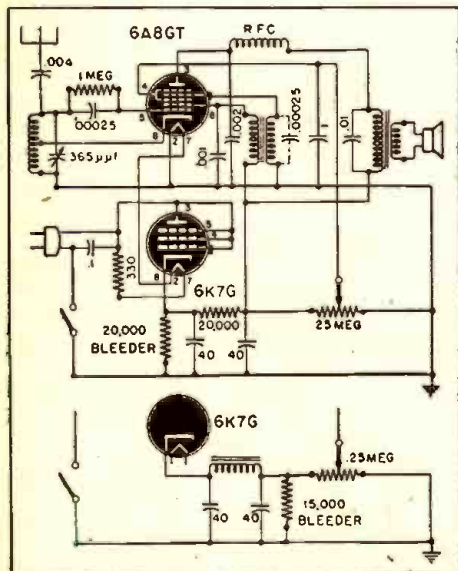

An original reflex circuit, whose efficiency may be due to some coupling in the 6A8 tube.

ELECTRONICS CONQUERS BUZZ-BOMBS

ELECTRONIC gun directors were the chief factor in making Hitler's buzz-bombs ineffective and driving him to try new weapons, according to Dr. Clarence A. Lovell, research physicist of Bell Telephone Laboratories. In an interview at Army Public Relations offices last month he gave a detailed account of the "Battle of the V-1's."

"The airplanes had the first go at the robots," said Dr. Lovell. "Only the fastest pursuit planes could overtake them, yet they were bringing down about 35% of all that crossed the coast line. Heavy anti-aircraft guns took care of about 10%, and lighter guns and balloons a few more, so that about half of those launched reached their target—London."

This set-up was far from satisfactory, and a reorganization was carried through, in which chief dependence was placed on artillery equipped with electronic gun directors. Percentages of bombs knocked down changed immediately. On one typical day, according to Dr. Lovell, 143 bombs reached the coast. Of that number the new artillery got 65—45% instead of the former 10%—the R.A.F. fighter planes brought down 35 (24%) and the barrage balloons

and other defenses stopped 17, leaving only 23, or 16%, to penetrate all defenses and reach the city. The tide in the Battle of London had definitely turned, and increasing dependence on the gun directors continued to reduce the number of bombs reaching their target.

A radio world's fair, first of its kind, was held last month in Mexico City. Importance of the industry was indicated by the large numbers of countries from both hemispheres who participated.

Outstanding attraction of the exposition is the foreign pavillions grouped around Mexico's Monument to the Revolution, which occupies the center of the Fair grounds. The building most frequently visited by the 50,000 to 100,000 daily fairgoers is that of Soviet Russia, which offers broadcasts of Cossack music.

The British Building presents an exhibit of the British Broadcasting Corporation and its 150 Latin-American affiliates. Other pavillions are France, Poland, the Spanish Republic, Czecho-slovakia, Yugoslavia, Brazil, Cuba, Peru, and the Dominican Republic.

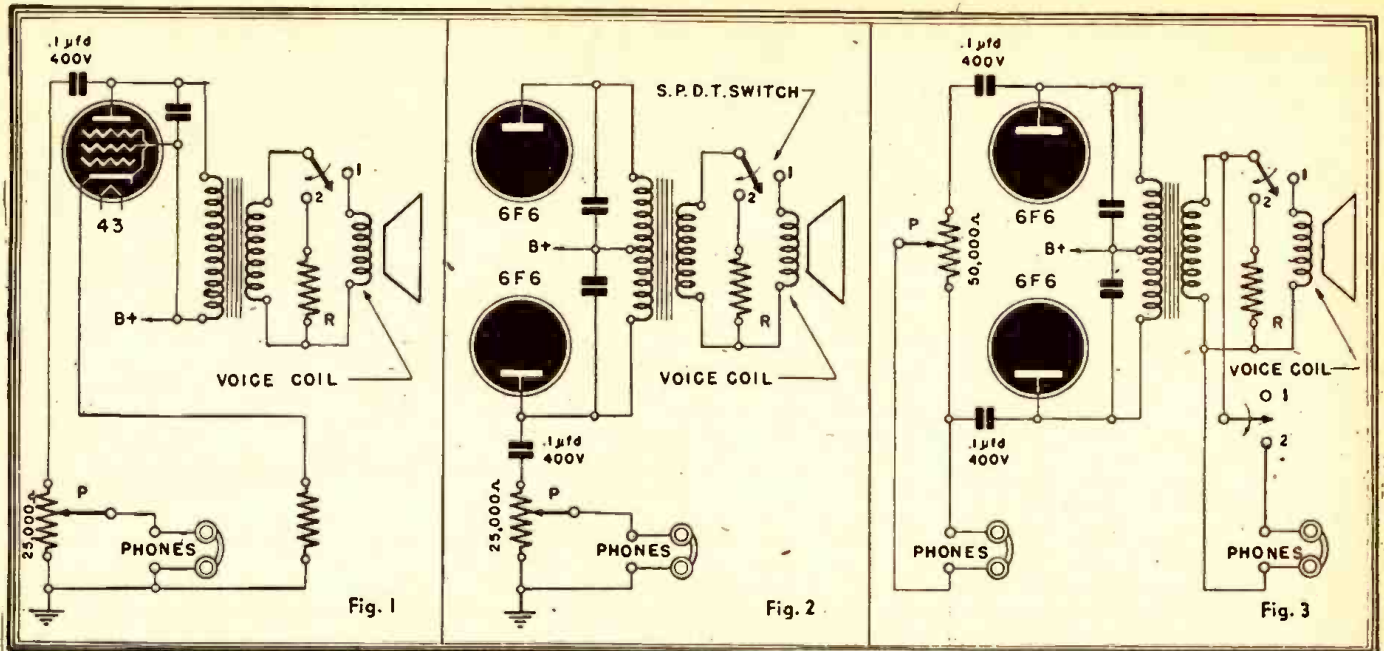

Fig. 1—Simple moderate-volume headphone connection. Fig. 2—A hookup for higher volume. Fig. 3—The best circuit. Switches are ganged.

Radio Headphone Circuits

By JOHN KEARNEY

MANY people need and want headphones added to their radios. Old folks may be slightly hard of hearing, and so fail to enjoy the loudspeaker at ordinary volumes. Using a suitable circuit, they can adjust the volume to suit themselves without injury to the radio, while if headphones were not used the volume might result in damage to the loudspeaker, rattling, etc., not to mention the inconvenience and unpleasantness caused those who have normal hearing. Late at night, headphones are a convenience, for others who may be sleeping are not disturbed. In the early days of radio, they were used exclusively and were quite popular. Today they are finding favor in hospitals and other places.

Fig. 1 shows how headphones may be added to a typical circuit. It is necessary to refer to a tube chart or a tube manual, unless you are a technical expert, to identify the plate terminal of the tube. A manual may be obtained by getting in touch with a radio supply house. The resistor R has a value equal to the voice coil resistance of the loudspeaker. In most cases it may be about 5 ohms, rated at 10 watts. The headphone volume is controlled by the setting of the volume control in the radio, but potentiometer P gives additional control. This allows setting the radio at desired volume level for regular loudspeaker operation with the S.P.D.T. switch at position 1 and at the same time prevents blasting of the earphones.

Many radios have push-pull power output tubes. Fig 2 shows one type of connection. Only one output tube is used in this circuit. This connection is practical and often used. A better and safer method—using both tubes—is shown in the left half of Fig. 3.

In all the circuits shown, the loudspeaker may be silenced if desired, or may be used at the same time the earphones are used, control being afforded by means of the S.P.D.T. switch.

The condenser connection to the plate of the tube should be short, direct and well insulated to prevent shorting the plate to

ground and burning out the primary of the transformer. Condensers should be of the 600-volt type. The soldered joint should be made with rosin core solder applied with a hot—really hot—iron so that a good soldering job will be done. The tip jacks may be mounted on a small piece of wood, bakelite or hard rubber and secured to the back of the cabinet with wood screws. The jacks

must not touch each other, as a short circuit would kill the headphone signal.

If the method shown in the right half of Fig. 3 is used, it will be necessary to have two S.P.D.T. switches, (or one single-throw and one double-throw) if it is desired to have the speaker either silent or in operation when the phones are used. If speaker and headphones are never to be used together, a D.P.D.T. switch will be more convenient.

New Idea in Detector Circuits

By W. T. CONNATSER

HERE is a receiver that brings in all kinds of distance with plenty of volume using but two tubes. Constructed from easily obtainable parts, I have received consistently stations within 100 miles by day and stations in Salt Lake, Denver, Portland, etc., by night, all with unbelievable volume, and sharp tuning. I use a 12 ft. indoor antenna.

The idea for this set was suggested by an item in the July *Radio-Craft*, "Progress in Invention" section. This showed a circuit in which the suppressor of an ordinary vacuum tube acted as a diode detector, while the tube still acted as an R.F. amplifier. I became interested in the circuit immediately, and built up and tore down several experimental models before arriving at this "final" design.

The schematic is simple. The first stage is unusual. The incoming R.F. signal coming through the first transformer, L1 (I used an iron core transformer with untuned secondary), is impressed upon the 6J7G. The amplified signal across the tuned plate circuit, L2, is impressed upon the suppressor (through a condenser).

The suppressor acts as a diode and current flows through the fixed and variable resistors, the voltage drop across the latter being placed on the control grid to vary its

average bias. The 6J7 therefore now amplifies at audio frequency, the output being across the 20 henry choke.

Coils L1 and L2 are ordinary broadcast coils of the iron-core type. The primary was removed from L2.

Note that the 2.5 mh choke prevents the passage of R.F., while the 100 microhenry condenser prevents passage of A.F. The second tube acts as A.F. amplifier and power rectifier. I find it advisable to use a trimmer in the plate tuning circuit.

Because of the multiple action of the first tube, this set is really hot!

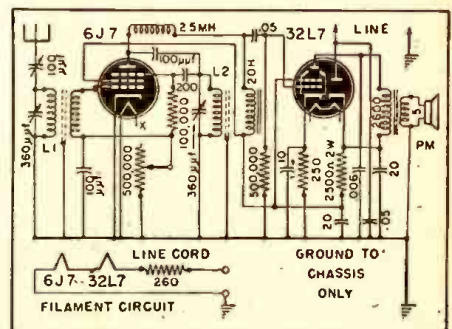

World-Wide Station List

Edited by ELMER R. FULLER

WITH the coming of spring, we should be able to pull in much better dx than has been heard during the winter months. The higher frequencies will be staying open longer in the evening, and receiving conditions will generally improve. The 16- and 19-meter bands have been fair in the daytime, but dead during the evenings, but as old Sol moves northward, he will bring some changes in these two bands with him.

A transmitter from Manila has been heard several times recently, being operated by the Japanese under the call C I R N and on a frequency of 15.430. By next month we expect that the BBC will settle down to one schedule for a few months, so we will bring to you a complete time chart such as the one presented for the United States stations. This is now in preparation.

K R H O is a new one in the Hawaiian Islands which has been coming in on 6.12

megacycles. It has also been heard a few times in point to point communication with NBC in San Francisco on 17.8 megacycles. Tokyo and Moscow should be heard much better as spring comes along; but at present they are heard only occasionally other than on the Pacific coast. Australian stations can be heard around eight in the morning, but by April should be heard at other times of the day, especially eleven and twelve at night. All schedules are Eastern War Time.

Freq.	Station	Location and Schedule	Freq.	Station	Location and Schedule	Freq.	Station	Location and Schedule
2.500	WVW	WASHINGTON, D. C.; U. S. Bureau of Standards, evenings only.	6.120	KRHO	HONOLULU, HAWAII; Japanese beam, 7 to noon.	6.900	XPSA	KWEIYANG, CHINA; heard 10:30 pm to 12:15 am; also 4 to 9 am.
2.880	GRC	LONDON, ENGLAND; 8 pm to midnight.	6.120	WOOC	NEW YORK CITY; European beam, 3:30 pm to midnight.	6.910	YNQW	MANAGUA, NICARAGUA.
3.480	YV4RQ	PUERTO CABALLO, VENEZUELA; heard starting off at 10 pm.	6.125	—	LONDON, ENGLAND.	7.025	DKSA	"SENDER ATLANTIK"; 9 pm to midnight.
3.500	YV5RX	CARACAS, VENEZUELA; sked not known.	6.130	CHNX	HALIFAX, NOVA SCOTIA.	7.053	COCL	HAVANA, CUBA.
3.500	CDX	HAVANA, CUBA; heard evenings.	6.140	WRUA	BOSTON, MASSACHUSETTS; European beam, 8:45 to 11 pm.	7.065	GRS	LONDON, ENGLAND.
3.510	YV3RS	BARQUISIMETO, VENEZUELA.	6.150	GRQ	LONDON, ENGLAND.	7.100	—	HAVANA, CUBA; heard at 9:30 pm.
4.020	—	PONTA DEL GADA, AZORES.	6.150	CJRO	WINNIPEG, CANADA; heard at midnight.	7.120	GRM	LONDON, ENGLAND; Pacific service at 1:45 am.
4.107	HCJB	QUITO, ECUADOR.	6.160	HCJD	BOGOTA, COLOMBIA; heard at 11:50 pm.	7.150	—	LONDON, ENGLAND.
4.700	ZQI	GEORGETOWN, BRITISH WEST INDIES; 5 to 7:30 pm.	6.160	CBRX	VANCOUVER, CANADA.	7.160	HCIBF	QUITO, ECUADOR.
4.765	HJFF	MANZALES, COLOMBIA; heard at 10 pm.	6.165	—	LONDON, ENGLAND.	7.171	XGOY	CHUNGKING, CHINA; East Asia and South Seas beam, 7:35 to 9:40 am; North American beam, 9:45 to 11:40 am; European beam 11:45 am to 12:30 pm; East Asia and South Seas beam, 12:30 to 1:45 pm.
4.780	YV3RN	BARQUISIMETO, VENEZUELA; heard at 9:45 pm.	6.165	HER3	BERN, SWITZERLAND; 9:10 to 11 pm except Saturdays.	7.185	—	LONDON, ENGLAND.
4.820	XEJG	GUADALAJARA, MEXICO; heard at 9:30 pm.	6.170	WCBX	NEW YORK CITY; European beam, 1 to 2:30 am.	7.190	COCG	HAVANA, CUBA; heard afternoons.
4.830	YV2RN	CARACAS, VENEZUELA; heard at 10:30 pm.	6.180	KRCA	SAN FRANCISCO, CALIFORNIA; Hawaiian beam, 4:30 am to noon.	7.205	—	LONDON, ENGLAND.
4.880	HJFH	ARMENIA, COLOMBIA; heard at 10:30 pm.	6.180	XGEA	CHUNGKING, CHINA; girl announcer; heard about 10 am.	7.205	EAQ	MADRID, SPAIN; heard at 10:30 to 11 pm.
4.890	YV5RM	CARACAS, VENEZUELA; evenings.	6.180	—	LONDON, ENGLAND.	7.230	KWID	SAN FRANCISCO, CALIFORNIA; Oriental beam, 5:15 am to 12:30 pm.
4.895	YDP3	SORABAYA, NETHERLANDS INDIES; heard at 8:45 pm.	6.180	HJCT.	BOGOTA, COLOMBIA.	7.230	GSW	LONDON, ENGLAND.
4.92	YV5RN	CARACAS, VENEZUELA; heard at 8:30 pm.	6.190	—	BERLIN, GERMANY.	7.240	DXJ	BERLIN, GERMANY.
4.955	HJQC	BOGOTA, COLOMBIA; evenings.	6.190	JLT	TOKYO, JAPAN; 9 to 10:40 am; 11 am to 2:40 pm.	7.250	WBOS	BOSTON, MASSACHUSETTS; South American beam, 8:30 pm to midnight.
4.965	HJAE	CARTAGENA, COLOMBIA; heard at 8:30 pm.	6.195	GRN	LONDON, ENGLAND.	7.250	KGEX	SAN FRANCISCO, CALIFORNIA; N. W. I. beam, 5 to 10:45 am.
4.99	YV3RN	BARQUISIMETO, VENEZUELA; heard evenings.	6.200	YV6RV	BOLIVAR, VENEZUELA; heard at 11:45 pm.	7.250	GWJ	LONDON, ENGLAND.
5.000	WVW	WASHINGTON, D. C.; U. S. Bureau of Standards.	6.220	DKSA	"SENDER ATLANTIK"; heard at 5:30 pm.	7.257	JVW	TOKYO, JAPAN; heard at 2 pm.
5.000	HJCA	BOGOTA, COLOMBIA; evenings.	6.230	—	MOSCOW, U. S. S. R.; heard early evenings.	7.260	SGU	LONDON, ENGLAND.
5.02	ZFA	BAJOEONG, AFRICA.	6.280	HIIA	CINDEA, TRUJILLO, DOMINICAN REPUBLIC.	7.270	DXL25	BERLIN, GERMANY.
5.145	PMY	BANDONG, NETHERLAND INDIES; heard about 8 pm.	6.345	HER4	BERN, SWITZERLAND; heard commencing on 5:30 pm.	7.280	—	LONDON, ENGLAND.
5.400	YDRI	BANDONG, NETHERLAND INDIES; heard about 3 am.	6.480	—	MOSCOW, U. S. S. R.; heard at 7:25 pm.	7.290	DJX	BERLIN, GERMANY.
5.935	PJC2	WILLEMSTAD, CURACAO; Saturdays only, 12 to 12:45 am.	6.490	CBR	VANCOUVER, CANADA; 9 to 9:30 pm.	7.300	—	CALCUTTA, INDIA; "Voice of Free India" heard 8:30 to 9 pm.
5.947	HH2S	PORT AU PRINCE, HAITI; 8:45 to 7 pm.	6.715	ZLT7	WELLINGTON, NEW ZEALAND; daily at 6 am.	7.315	YSO	SAN SALVADOR, EL SALVADOR.
5.985	—	"RADIO ANDORRA"; heard going off at 7:30 pm.	6.880	—	MOSCOW, U. S. S. R.; heard at 7:25 pm.	7.320	GRJ	LONDON, ENGLAND; heard evenings.
6.000	ZFY	GEORGETOWN, BRITISH GUIANA; weekdays, 6:45 to 7:15 am; 10:45 am to 12:45 pm; 3:45 to 8:15 pm; Sundays, 6:45 to 9:45 am; 2:45 to 8:15 pm.				7.370	KEQ	KAHUHU, HAWAII; heard at 3 pm.
6.000	ZOY	ACRA, GOLD COAST; 10 pm to 1 am.				7.380	NCN	U. S. NAVY AT GUAM.
6.005	CFCX	MONTREAL, CANADA; Sundays, 7:30 am to midnight; Monday to Saturday, 6:45 am to midnight.						
6.005	VE9AI	EDMONTON, CANADA; midnight to 2 am.						
6.007	ZRH	JOHANNESBURG, SOUTH AFRICA; midnight to 3 am, except Saturdays.						
6.010	GRB	LONDON, ENGLAND.						
6.010	CJCK	SYDNEY, NOVA SCOTIA.						
6.018	HJCK	BOGOTA, COLOMBIA; heard at 11:55 pm.						
6.020	DJC	BERLIN, GERMANY; African service, 2 to 5:30 pm.						
6.030	DXP	BERLIN, GERMANY; evenings.						
6.035	—	LONDON, ENGLAND.						
6.040	—	ALLIED NATIONS RADIO — ALGIERS; heard going off at 12:30 pm.						
6.040	WRUW	BOSTON, MASSACHUSETTS; Central America beam, 9:30 pm to 2 am.						
6.040	WRUA	BOSTON, MASSACHUSETTS; European beam, 4 to 7:15 pm; 7:30 to 8:30 pm.						
6.050	GSA	LONDON, ENGLAND.						
6.060	WCBN	NEW YORK CITY; Mexican beam, 7:30 pm to 2 am.						
6.070	CFRX	TORONTO, CANADA; Sundays, 9 am to midnight; Monday to Friday, 7:30 am to 12:05 am; Saturday, 7:30 am to 12:45 am.						
6.070	—	LONDON, ENGLAND.						
6.080	WLWK	CINCINNATI, OHIO; South American beam, 8:30 pm to midnight.						
6.080	CKFX	VANCOUVER, CANADA.						
6.090	—	LONDON, ENGLAND.						
6.090	ZNS2	NASSAU, BAHAMAS; heard at 6 pm.						
6.090	CBFW	VERCHERES, CANADA; (French).						
6.100	KROJ	LOS ANGELES, CALIFORNIA; Australian beam, 4 to 9 am.						
6.100	WNRX	NEW YORK CITY; European beam, 4:45 to 11 pm.						
6.100	VPD2	SUVA, FIJI ISLANDS; 1 to 3 am.						
6.100	XGAW	JAPANESE CONTROLLED CHINA; heard about 1 am.						
6.110	DSL	LONDON, ENGLAND; North American service, 8 pm to 12:45 am.						

(Continued on page 367)

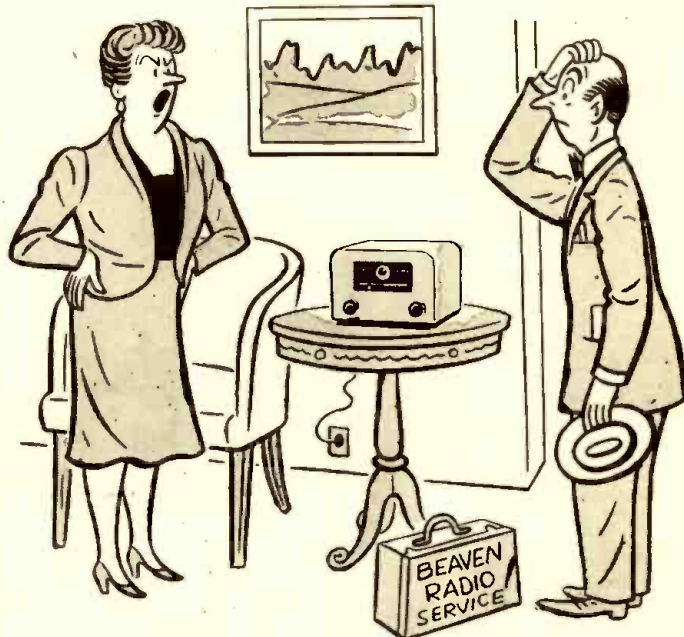

Suggested by: E. F. Weight, College Station, Texas

"Take your radio out of here, that electric eye always winks at me."

RADIO JOCKEY

Electronically-Controlled Robot Rider

HORSE-RACING—the game of kings—has one great weakness. The suspicion of “fixed” races, of “pulled” horses and of dishonest jockeys, has prevented this sport from taking its place with such American national institutions as baseball or football. Even where track officials make every effort to keep their races “clean,” an unsavory aura still attaches to the practice of racing horses.

A freak race in the early days of radio broadcasting gave rise to suggestions for a type of horse-race in which the jockey would be eliminated. The event referred to took place at the Cook County Fair, Chicago, in 1922. A horse—appropriately named Radio—raced with no jockey other than a radio receiving set and a horn loud-speaker on his back. His jockey, or more properly trainer, remained in the stands at the microphone of a small transmitter, giving directions and shouting encouragement. According to reports, as the horse came into the home stretch the trainer shouted, “Come on, Radio! Come on, boy!” and the horse responded nobly, just as if the trainer had been sitting on his back and was urging him on toward the finish line.

Spectacular as the stunt was at that stage of the development of radio, it proved only that the speaker was no substitute for a jockey, who not only with voice, but with hand and heel, urges his mount on to victory.

Some years ago H. Gernsback proposed a device which uses equipment and methods not available in 1922 to supply all these. The loud-speaker works as in the older set-up, the reins and crop are controlled from transmitters in the stands, at which the trainers can sit comfortably while watching the progress of their “mounts” at any part of the track.

The “jockey” would consist of a modern radio receiver, with outputs fitted both to a speaker and to relays which would set into action motors which control the arms to which the reins are attached, or operate the crop. Additional motors can be provided—or attachments made to those

By ERIC LESLIE

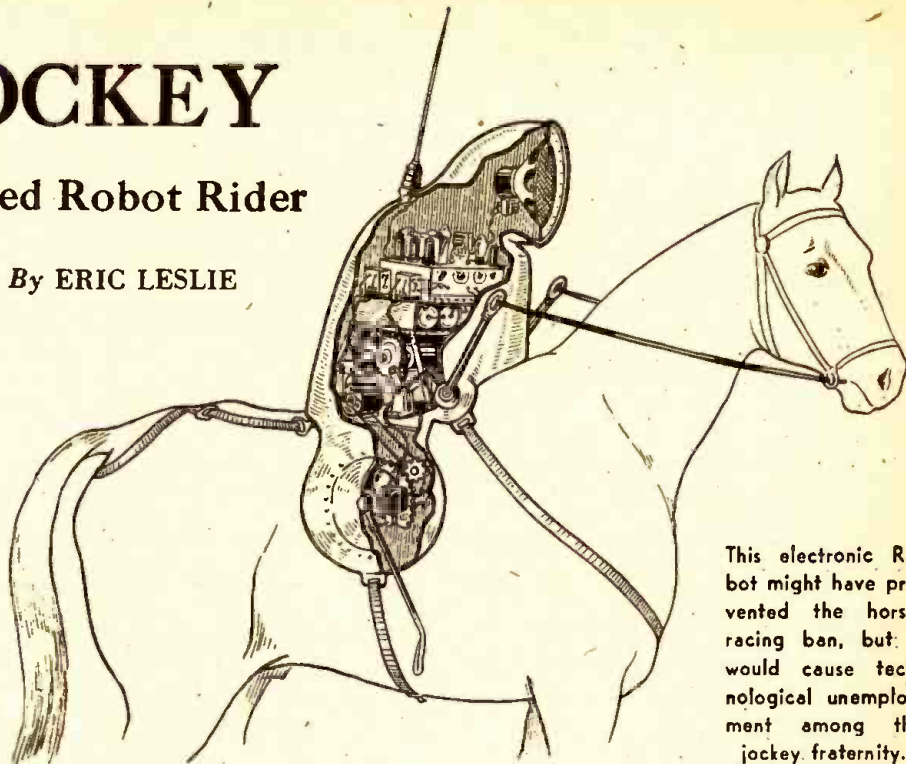

This electronic Robot might have prevented the horse-racing ban, but it would cause technological unemployment among the jockey fraternity.

used—which would permit changing the posture of the “jockey,” causing it to lean further forward or rise upright, to sway to the left or the right, as may be required during the race. It is well-known that a jockey uses his body as well as his voice and the reins in guiding his horse.

Should there be any suggestion of “pulling” or other unfair action, it would not be necessary to depend on the opposed statements of a pair of jockeys, neither of whom might have been in the best condition—either physically or emotionally—to note actually what had happened during the portion of a second in which many of these incidents occur. A complete record of all the jockey’s actions can be kept on a tape which would form a part of the transmitting apparatus, so that there could be no dispute as to how any incident had occurred or how much restraint was applied to a horse at any given period during a race.

Old-time sports may believe that such a system would take the “kick” out of racing, but they do flock to the dog-races to watch the electric rabbit!

FM FOR EDUCATION

Speaking before the annual meeting of the National Council of Chief State School Officers in Baltimore, FCC Commissioner Clifford J. Durr suggested that educational institutions enlist the engineering talent in their own ranks for the purpose of planning a nation-wide FM educational broadcast structure. Radio technical experts on the faculty staffs of educational institutions should be organized, he believed, both at the national and state levels into committees to assist in broad-scale FM planning.

On the issue of spectrum space he stated that the old question of “Will these few (educational FM) channels be used?” has been transformed to “How many more channels will be required?” He could not answer this question any more than he could tell whether “FM broadcasting will remain in the same part of the spectrum now assigned to it or will be moved elsewhere where there is more room,” for the Commission was still giving consideration to these and the other tremendously complicated allocation problems.

One point regarding the filing of FM applications deserves note by potential commercial FM broadcasters. “The chief problem . . . it seems to me, has heretofore been that they have been filled out as a preliminary to planning stations rather than as the last stage of planning.” If basic planning be done first the filling out of applications will be much easier, the Commissioner believed.

Educators might well investigate the surplus stocks of the Army and Navy as a possible source of economical broadcast equipment for FM stations, as large stocks of these lines might be available.

Commissioner Durr pointed out to the educators the urgency of prompt action in the FM field if they are to make the most of opportunity. Unless plans for state educational networks are completed in time, he stated, the FCC may be forced to grant applications now before it without respect to a state-wide plan.—FM

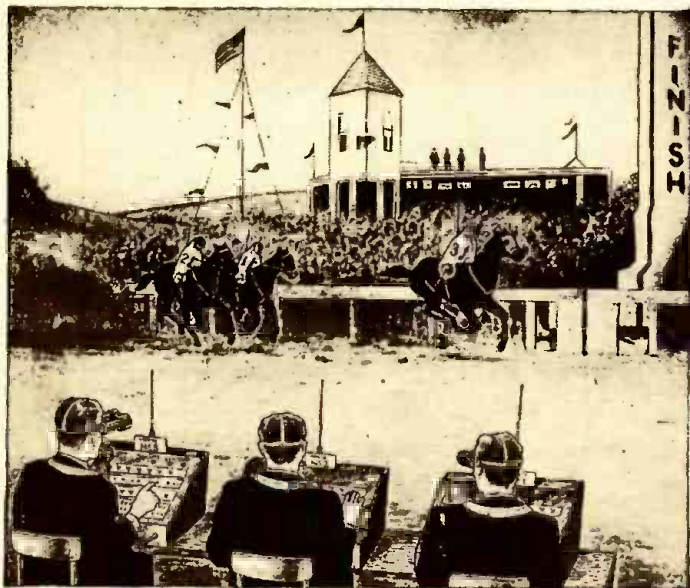

“Jockeys” who are electronic experts, and have to watch their fingers instead of their weight may help to make this proposed Radio Robot a reality.

Phonograph "Buzz" Cure

ONE type of phonograph distortion often present but seldom discussed is that known as *needle buzz*. It results from the fact that the pickup stylus (spherical tip) is different from the cutter (sharp pointed). This type of distortion, especially bad in vertical recordings, is also present in laterally-cut discs. The problem was discussed in the October, 1944 *Wireless World* (England) and possible solutions described.

The action of the cutter and stylus is illustrated in Fig. 1. Dotted lines in Fig. 2 are the actual movement of the stylus, full lines are the groove itself. The effect is emphasized during loud high frequency passages.

If recording and reproducing were done with the same shape of needle, no distortion would result. However, process limi-

tations require a sharp cutter. On the other hand, excessive needle wear would result from a sharp stylus, and a thin lamination of either diamond or sapphire would not last long.

A suggestion is made that a "hairpin" needle be made up as in Fig. 3. Here one wire is looped around another. This arrangement will follow the groove without distortion. The diameter of the wires shown are: a, 50 SWG, .001 inch, wrapped around 42 SWG, .004 inch; b, 47 SWG wrapped around No. 47 SWG, .002 inch; so that a steady hand and a magnifying glass are required. The "needle" may then be supported by celluloid and cemented. (Fig. 4) The wire for the hairpin may be nickel-chrome or nickel-iron and it may be chromium plated. The support wire may

conveniently be of soft copper. It may be desirable to spot-weld the two wires.

The wear on the hairpin wire is considerable, so that another improvement

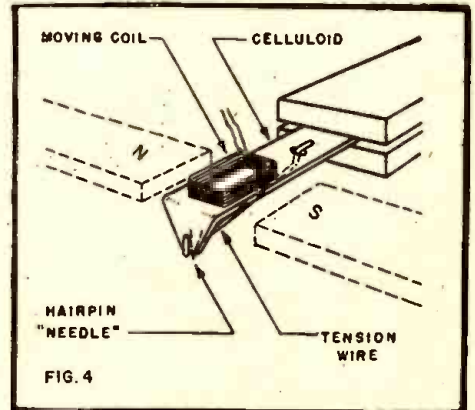
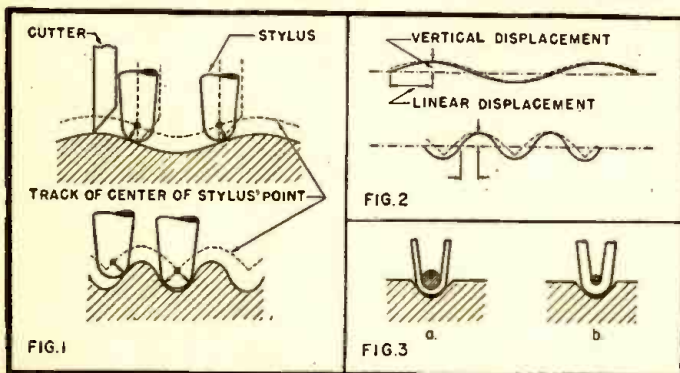

Fig. 4—Moving-coil pickup with wire needle.

Left, Fig. 1—Track followed by needle differs from record track. Fig. 2—Lateral and vertical displacement on lateral recordings. Fig. 3—The proposed fine-wire Phono needle.

would consist of a continuous wire feed, so that the worn wire may be replaced after each record.

The author of the *Wireless World* article states that he has played half-a-dozen records with one of these needles, and while improvement in quality was promising, microscopic examination showed that the thin wire had been worn half away.

PRACTICAL HOME-STUDY RADIO COURSE

These men used this course to get into good radio jobs



FINEST TRAINING COURSE USED IN MANY SCHOOLS

"The radio training course is the finest up to date easy to understand course. . . . This course outlines practical work. We are using this course in our Topeka High School. It is wonderful." *Henry Ward, Jr., 622 Filmore St., Topeka, Kans.*



WORTH MUCH MORE

"You should get more money for your course. The first week I studied it, I made \$10.00 repairing sets. I built my own test outfit from details given in this course. I have repaired 100 radios to date. Signed: *Robert C. Hammel, 709 E. 10th, Davenport, Iowa.*



COMPLETED IN 8 WEEKS

"I am very satisfied with the course. When I was at the twelfth lesson I started repairing radios. It took me two months to master your course." From a letter written by *Roger Lanzlois, 1720 Poupart, Montreal, Canada.*



MODERN, UP-TO-DATE

"I have found since taking your course how modern and up to date it really is. There is not one page in the whole course which anyone interested in radio can afford to miss. Your course started me on the road to a well paid job and has repaid me many times." *Charles Alspach, 433 Elm St., Reading, Pa.*

AMAZING BARGAIN OFFER

In this large course-manual of 22 practical lessons, you have all the topics covered by the best \$100.00 radio correspondence course. Learn important fundamentals. Speed-up radio servicing. Includes hundreds of circuits, thousands of repair hints, many servicing short-cuts.

RADIO TRAINING FOR HOME-STUDY

This practical home-study course will show you how to repair all types of sets faster and better, tell you how to open your own shop and run the business. The lessons are well illustrated, interesting to read, easy to understand and apply. No special previous knowledge is needed. The early lessons explain important principles. Other lessons cover test equipment, trouble-shooting, circuit tracing, television, and every other important topic of radio and electronics.

SERVICING METHODS SIMPLIFIED

Learn new speed-tricks for radio fault-finding, case histories, servicing short-cuts, extra profit ideas. Included are many large lessons on the use of regular test equipment, explanation of signal tracing, oscilloscope, transmitters, P.A., television, recorders. Let this information save for you enough time on a single job to pay the full price of \$2.50 for the complete course of 22 money-making lessons.

A PARTIAL LIST OF TOPICS COVERED

Circuits, Auto sets, P.A., Tube Characteristics, A.C., Fidelity, Using charts, Amplifiers, Tracking, I.F., Phase, Reactance, Impedance, Modulation, A.V.C., Photo-cell, Review questions, Crystals, Test equipment, Meters, Analyzers, Tube testers, Signal tracing, Oscilloscope, Ohm meters, Accuracy, Graphs, and hundreds of other topics.



IN MANUAL FORM

\$2.50 COMPLETE

SPECIAL OFFER READ THE DETAILS

EASY TO UNDERSTAND AND APPLY

The practical lessons making up this course-book are easy to follow and apply to actual radio jobs. Hundreds of radio facts that puzzled you will be quickly cleared up. You will find yourself doing radio repairs in minutes instead of hours—quickly finding the faults or making needed adjustments. Every new radio development of importance and thousands of time-saving radio facts are packed into this complete course-manual.

SATISFACTION GUARANTEED

Use coupon to order the Course for 10-day examination in your own home. Look over the material, read a few lessons, apply some of the ideas. Then decide to keep the lessons at the bargain price of \$2.50 (full price), or return the material and get a cash refund.

TRIAL ORDER COUPON

SUPREME PUBLICATIONS, 9 S. Kedzie Ave., Chicago 12, ILL. Ship the complete Radio Course for 10 days use. I must be satisfied or you will refund my money.

- I am enclosing \$2.50, full price. Send postfree.
 Send C.O.D. I am enclosing \$..... deposit.

Name:

Address:

(Use Coupon or Send Order in a Separate Letter)

New Radio-Electronic Devices

WELDING TIMER

Electrical Industries, Inc.
Newark, New Jersey

THE electronic timing control is easily applied to either existing or new installations; a single knob gives instant time control from 1 to 28 cycles in steps of one cycle. Welding current is electronically switched, with absolute freedom from contactor uncertainties, maintenance, arcing and pitting. The device handles welding powers of from 1/2 to 5KVA.—*Radio-Craft*



INDICATING LIGHT

H. R. Kirkland Co.
Morristown, New Jersey

THE De Luxe No. 659 D/E Unit is of such a shallow-depth that it can be used where most other units cannot be used; the overall depth behind the front of the panel to the extreme end of the insulation barrier is only 1". It is for single-hole mounting in a 1 3/8" diameter hole in panels up to 1/4" in thickness.

The molded bakelite socket is of the candelabra screw base type for use with the S6-120 volt tungsten lamp or the T4 1/2 Neon glow lamp. A 1/4" square insulation barrier separates the two 6/23 terminal screws. The terminal screws go directly to the two sides of the lamp contacting members providing a direct-line electrical contact, without the use of solder or the employment of a "press-fit" assembly.—*Radio-Craft*

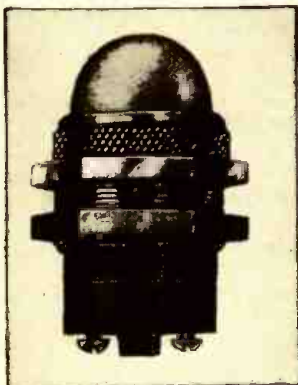

360

PHOTOMETER

General Electric Co.
Schenectady, N. Y.

THIS new photometer is desirable for use wherever spectrographic analysis is employed, such as in the metal fields, and also for microcolorimetric and microchemical analyses and for measuring light transmission through solutions.

Requiring a constant power supply of 6 volts, A.C. or D.C., with an approximate capacity of 30 amperes, the photometer consists essentially of a light source, an optical system, a galvanometer, a light-sensitive cell, and a mechanical stage for accommodating the plate. This stage, which has a three-point, ball-bearing suspension, is movable in three directions, thus providing smooth, precise control of the position of the plate. Control knobs conveniently mounted on the front of the instrument facilitate focal adjustment and control of the several diaphragms and filters in the optical system which governs the intensity of

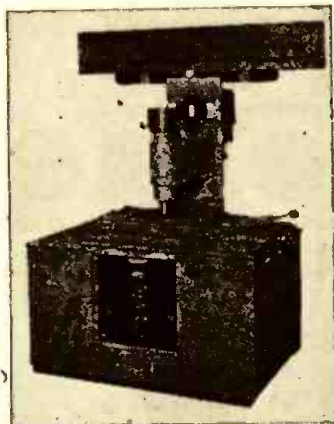

the light and heat reaching the light-sensitive cell and the plate. Mounted in an attractive, sturdily constructed case, the instrument is especially easy to operate, since all adjustments can be made and seen readily from a single position.—*Radio-Craft*

SELENIUM RECTIFIER

Selenium Rectifier Products
Newark, New Jersey

CENTER CONTACT, a patented plate construction in metal-plate rectifiers which allows complete coating protection against destructive atmospheres, is available in units developed especially for use in equipment being manufactured for the Army and Navy. This type of construction permits a new method of applying protective coatings to metal-plate rectifiers. Where the standard petal contact is sprayed with a

protective coating, Center Contact is especially adapted to the application of a heavier and better coating to protect the rectifier from fungus-bearing, salt-spray-laden or corrosive atmospheres. In such applications, the metal plate rectifiers are necessary as other types of rectifiers cannot be completely protected against such destructive conditions.

This feature is especially valuable in military equipment intended for use in tropical areas which are affected by moisture and by high atmospheric salt content.—*Radio-Craft*

SEALED RELAY

Betts & Betts Corp.
New York, N. Y.

THE COROSEALED relay is a midget type relay especially designed for communication, electronics and aviation applications. These relays are hermetically sealed in a metal shell assuring perfect performance under severe conditions of temperature, humidity, pressure, dust, corrosion and fungi.

Units are normally sealed with content of pre-filtered dry air but can be furnished with inert gas or pressurized content.

This component incorporates a standard octal plug base to facilitate testing. Unit is 1 11/16" long—2 7/8" including prongs. Weight only 4 ounces.

Coil windings can be supplied for voltage ranges from 1.5 to 70v DC and are wound to exact number of turns. Every unit is subjected to a 1000 volt break-down test. Inorganic base plastic insulation minimizes high frequency loss and assures permanent dielectric and mechanical strength.

Contact arrangements offer flexibility in arrangement and handle 2 amps. at 100 watts.—*Radio-Craft*



NEW POTENTIOMETERS

DeJur-Amsco Corporation
Shelton, Conn.

PRECISION potentiometers which can operate for 2,500,000 revolutions at 360° continuous rotation in both directions, for 24 hours a day are among the types brought forth by the DeJur-Amsco.

Among these models are Types 260, 275, 261, 260T, and 291. Outstanding feature of this group is the fact that extremely close tolerances are used.

Constant contact resistance and low noise level are maintained for any position of the knob through the use of separate wiping fingers.—*Radio-Craft*

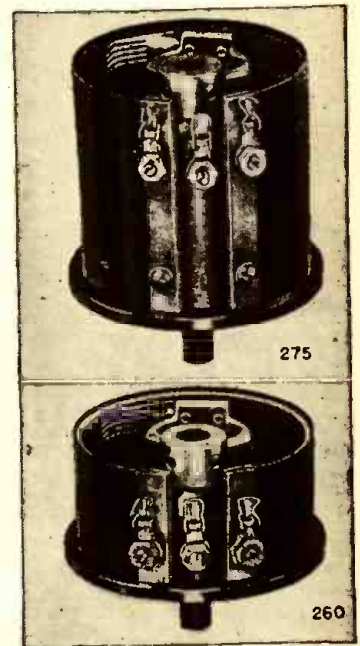

TESCO WRENCH

Eastern Specialty Co.
Philadelphia, Penna.

HAVING the same approximate dimensions as a single socket wrench and with very little additional weight, this new Multi-Socket Wrench automatically accommodates No. 10 standard, No. 12 standard, 1/4-inch standard and light, and 5/16-inch light hexagon nuts. Merely by pressing the wrench over any of the three sizes of nuts automatically selects the proper nested hexagonal tube suited to that particular nut.

By no means a "gadget," the Tesco Socket Wrench is specifically designed for heavy duty service, making it unexcelled for factory production or servicing work of any kind. Its design is such that any stress incident to turning a nut is transferred to the outer hardened-steel casing.—*Radio-Craft*

RADIO-CRAFT for MARCH, 1945

A Pair of New Tubes

PRESENTING sharp contrasts in weight and size as well as in functions, two tubes recently announced by the Radio Corporation of America are a forced-air-cooled transmitting triode weighing 235 pounds and measuring 25 inches in height, and a miniature thyratron weighing only half an ounce and measuring 1 7/8 inches.

The forced-air-cooled RCA-9C22 and its "sister" tube, the water-cooled RCA-9C21, are both suited for use in the class B modulator stage and in the plate-modulated class C final amplifier stage of high-power transmitters, as well as in large units for high-frequency heating.

A pair of either type has ample power-delivering ability for the final stage of a 50-kilowatt broadcast transmitter. For industrial heating applications, a pair of 9C22's, operated as unmodulated class C oscillators, will provide a tube output up to 130 kilowatts. A pair of 9C21's under the same conditions will furnish up to 200 kilowatts. These new types may be used with maximum ratings at frequencies as high as 5 megacycles, and with reduced ratings at frequencies up to 25 megacycles.

Design features of the 9C21 and 9C22 include a multi-strand, single phase tungsten filament, and an entrant metal header which provides short internal connections between the filament and filament terminals. In addition, the grid is mounted directly on the header, the flange of which serves as the grid terminal. This construction provides an extremely short, heavy-current, low-inductance path to the grid, a feature of particular importance for operation at the higher frequencies.

The new thyratron, RCA-2D21, despite its tiny size, provides stable operations and a high control ratio for a variety of functions as an electronic switch. It will carry 0.1 ampere plate current continuously, and for periods up to 6 seconds out of 30 will safely carry 0.5 ampere. Employing xenon filling instead of mercury vapor, it is free of the limitations imposed by the use of

mercury on mounting position, and free of the need to restrict motion while in operation.

Other features of this gas-type tetrode include quick heating (anode voltage may be applied 10 seconds after application of heater voltage), wide temperature range (-55 to +90°C with little change in operating characteristics), low internal drop (only 8 volts), low pre-conduction current, versatility of control (either by shield grid or by control grid), and high sensitivity.

An auto antenna which will be raised and lowered by a small electric motor is projected by a large car-radio manufacturer.

HOW MUCH Should Good Radio-Electronic Training Cost?

★ The answer is that the best basic Radio-Electronic Training that money can buy **NEED NOT COST YOU MORE THAN \$5.** Ghirardi's is as complete as any book or course at any price—and far more complete than most. It is easier to learn from. It is the basic training most widely endorsed by Radio experts themselves. It is more widely used by Army, Navy, and civilian schools and for more home study than anything else of its kind. Best of all, you can actually see it, study it, and compare it **BEFORE YOU BUY!**
See Page 381 for details.
MAIL COUPON AT ONCE!

Basic Design

makes the difference!

Smudge-voice

While these two columns read identically, word for word, the smudged column is a visual representation of an acoustical condition when background noise interferes with transmitted speech.

The words may be readable, but effort and concentration are required for accuracy. And so with reproduced sound: with general purpose microphones, articulation is lowered even though ambient noises do not completely override speech. The Electro-Voice Differential is specifically designed to erase interfering background noise. Speech is clean, clear, crisp... undistorted by stray pickup or distracting background.

Electro-Voice

While these two columns read identically, word for word, the smudged column is a visual representation of an acoustical condition when background noise interferes with transmitted speech.

The words may be readable, but effort and concentration are required for accuracy. And so with reproduced sound: with general purpose microphones, articulation is lowered even though ambient noises do not completely override speech. The Electro-Voice Differential is specifically designed to erase interfering background noise. Speech is clean, clear, crisp... undistorted by stray pickup or distracting background.



RADIO-GRAFT for MARCH, 1945

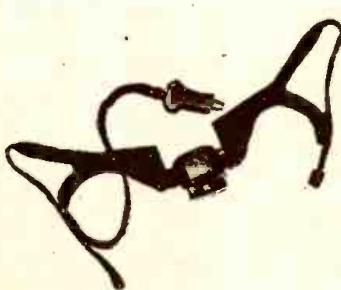

Electro-Voice DIFFERENTIAL MICROPHONES

Electro-Voice engineers have years of experience in the elimination of ambient noise. We designed and developed the now-famous "Lip-Mike," the first successful Differential microphone. Our new Model 205-S for aircraft, railroad, industrial and police applications is another Differential achievement. Soon there will be Electro-Voice Differential microphones for all communication services. Watch for them.

If any of your limited quantity needs can be met by standard model Electro-Voice microphones, with or without minor modifications, contact your local radio parts distributor.



BLOOD DONORS ARE URGENTLY NEEDED... SEE YOUR LOCAL RED CROSS

Electro-Voice MICROPHONES

ELECTRO-VOICE CORPORATION • 1239 SOUTH BEND AVENUE • SOUTH BEND 24, INDIANA
Export Division • 12 East 40th Street, New York 16, N. Y. U. S. A. Cable: Arlab

Radio-Electronic Circuits

LINE FILTER

The drawing below illustrates the components and hook-up of an efficient power line filter to reduce interference and hum from the AC primary input to radio receivers.

The input condensers are mica, while those at the receiver end are paper. The first by-pass radio frequency, the second, audio and hum.

The chokes are magnet windings from an old pair of B-vibrators. They may be wound, using size 16 enamel magnet wire, on a wooden spool. Leaving out the iron core will not make much difference.

The unit is enclosed in a metal shield to which the condensers are grounded. The shield then is grounded externally to a water pipe—separate from the receiver ground.

A short length of twisted line cord is brought out of the shield and fitted with a plug-in receptacle at the receiver end, while a six-foot length of line cord, with a regulation plug to fit the wall socket, is brought out at the other end.

The unit may be mounted inside the radio cabinet, or on the wall out of sight behind the cabinet.

If you wind the chokes, put on from 150 to 200 turns. Good results have been obtained with rolls of bell wire.

EMMETT BRIGHTWELL,
San Francisco, Cal.

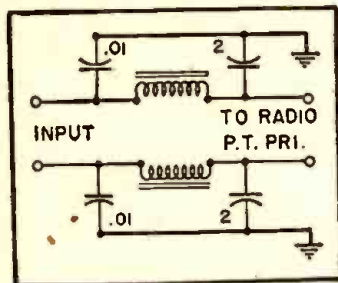

HI-FIDELITY AMPLIFIER

This push-pull circuit delivers four to five watts of undistorted power. The voltage doubling circuit provides adequate voltage on the plates. An 8-inch speaker is recommended. (See Fig. 1)

The phase inverter (6SC7) feeds an out-of-phase signal to the power stage. The 70L7 tubes are combined amplifiers and power rectifiers.

The two 70L7's in series with the 6SC7 and 150-ohm resistor make an excellent filament combination, but by varying the filament resistor other types of tubes could be used.

JOSEPH F. DUNDOVIC,
LaGuardia Field, N. Y.

Radio-Craft welcomes new and original radio or electronic circuits. Hook-ups which show no advance on or advantages over previously published circuits are not interesting to us. Send in your latest hook-ups—Radio-Craft will extend a one-year subscription for each one accepted. Pencil diagrams—with short descriptions of the circuit—will be acceptable, but must be clearly drawn on a good-sized sheet of paper.

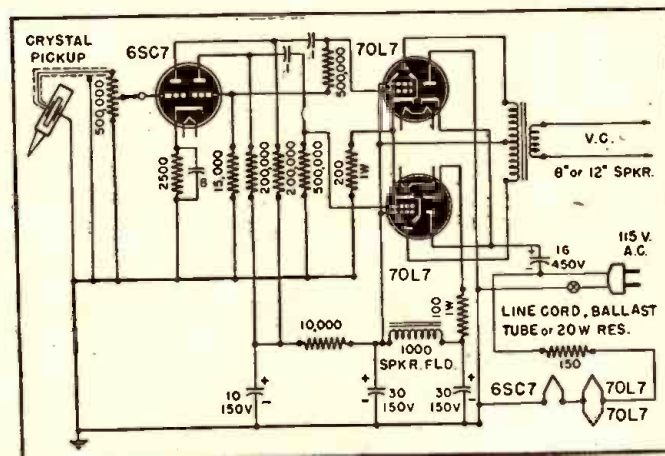

Fig. 1—An efficient high-fidelity amplifier for phonograph work.

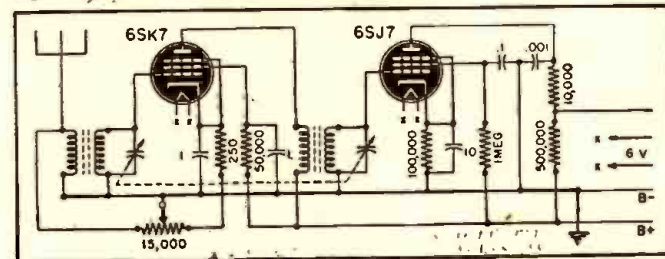

Fig. 2—This tuner will make a good radio out of a P.A. amplifier.

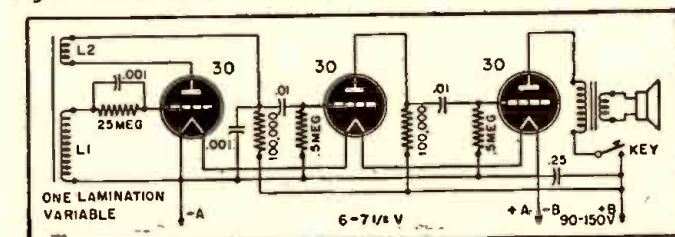

Fig. 3—Amplification makes this a code oscillator for large classes.

R.F. TUNER

This simple but efficient tuner may be added to any P.A. system, to make up a high-fidelity receiver. Quality is excellent and selectivity is good enough for practically all locations. (See Fig. 2)

The use of iron-core coils gives good sensitivity. Connections to the amplifier may be made by a five-wire cable. In this circuit the center-tap of the filament transformer was grounded, constituting the -B lead and ground. If one side of the filaments is grounded (instead of the center tap) only four wires are required.

EDWIN BOHR,
N. Chattanooga, Tenn.

G.I. CODE OSCILLATOR

Being in need of a CW oscillator, we G.I.'s made up this little set in a small plastic cabinet using the original receiver speaker (magnetic). (See Fig. 3)

Battery leads are connected to a five-prong plug to fit a G.I. radio battery. L₁, L₂ is an audio transformer with laminations removed. The note is lowered by inserting one lamination.

Two stages of audio may look extreme to designers who use one tube to produce loudspeaker signals, but we find that a loud enough note to over-ride classroom noises is essential. The pitch-changing lamination is also very useful in getting a clear and penetrating tone.

SGT. CLARENCE J. ANDERSON,
New York City.

HI-LO TONE CONTROL

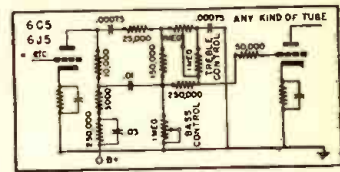

Several months ago while building an amplifier I was confronted with the problem of a suitable tone control which would have the following requirements:

1. No tone chokes. (Only standard resistors and condensers.)
2. Separate controls for bass and treble.
3. Absolutely no interaction between bass and treble controls.
4. Controls to work smoothly with no jumps and must be very EFFECTIVE, able to produce any tonal combination possible.
5. Simplicity and ease of construction with available materials.

After considerable search I finally came across a hookup that has all of these features. Here it is for others who are looking for the same thing. When adding it to an amplifier one should keep the leads as short as possible and it should be preceded by several stages of audio amplification to minimize any possibility of hum pickup.

DONALD W. NELSON,
Seattle, Wash.

ONE-TUBE TRF SET

This gives the maximum performance for the number of components. This set has a stage of R.F., diode detector, A.V.C. and two stages of A.F. Signal is applied to the pentode. The output is passed to the R.F. transformer and to the diode where it is detected

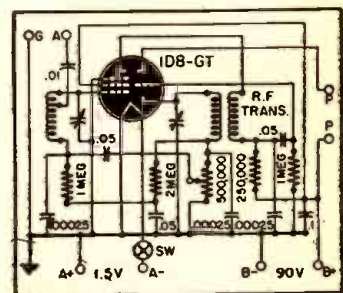

ed and the output applied again to the pentode control grid. The A.F. output is now resistance coupled to the triode grid, and finally appears at the output terminals.

SGT. L. R. BLATTNER,
Tinker Field, Okla.

SHORT-WAVE CONVERTER

This short-wave converter was made entirely from parts out of the junk box. The two variable condensers are the old type. I removed all the stator plates but two, giving a capacity of about 100 mmf.

Condensers are *not* ganged. The tubes were old ones which happened to be on hand. The constructor could use a 6A7 and a 75 or a 6A8 and a 6Q7 if he has a 6-volt supply. Another type of triode would probably work well, say a 56, 76 or 6C5.

I wound the antenna and oscillator coils on four-prong tube bases with No. 22 enamelled wire. L1 has 7, L2 12, L3 8 and L4 10 turns. These cover from the 7 to the 11 megacycle band.

My "B plus" lead was connected to the screen-grid lead of the power amplifier tube in the B.C. receiver and I used a separate transformer for the filaments. The converter works best on a receiver with automatic volume control.

I have received stations from Tokyo to Brazzaville with this converter. The London stations come in very well, as do the United States short-wave stations.

RICHARD E. HELD,
Sioux City, Iowa.

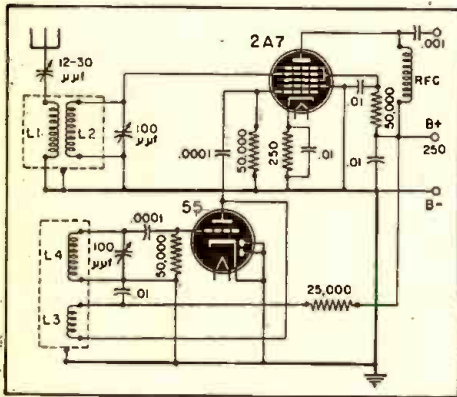

A LUCKY ACCIDENT

A sheer accident is said to have spurred the development of modern-type, small-size quartz crystals, resulting in great savings in this critical war material, as well as in cost of production and in man hours. Before the start of the present war a radio "ham" in South Africa—a minister with a mechanical turn of mind—happened to drop and break a crystal which he had secured from a United States concern. The precious crystal broke into three pieces, two of them being small fragments no bigger than his thumbnail. Anxious to keep his set working if possible, he tried out the larger piece—and found that it functioned as well as the entire crystal had done. Amazed, he tried out the smaller fragments and found that they too worked successfully.

Hardly believing that his luck would hold, he wrote to the concern in the States ordering a new crystal, but reported, parenthetically, that the pieces of his old one worked "all right." At that time there was a very ample supply of quartz crystal for current peacetime needs, but with the coming of war to Europe, and more particularly with the coming of war to America, the demand was stepped up prodigiously. From that point on, the size of the crystals used in radios ceased to be merely of academic or scientific interest. It was a matter of life and death to our fighting men and to our whole war effort.

Company experts remembered the old letter and ran tests, resulting in the design of crystals many times smaller than the old.

RADIO-CRAFT for MARCH, 1945



THERMOSTATIC METAL TYPE DELAY RELAYS PROVIDE DELAYS RANGING FROM 1 TO 120 SECONDS

Other important features include:—

1. Compensated for ambient temperature changes from -40° to 110° F.
2. Contact ratings up to 115V-10a AC.
3. Hermetically sealed — not affected by altitude, moisture or other climate changes. Explosion-proof.
4. Octal radio base for easy replacement.
5. Compact, light, rugged, inexpensive.
6. Circuits available: SPST Normally Open; SPST Normally Closed.

WHAT'S YOUR PROBLEM? Send for "Special Problem Sheet" and Descriptive Bulletin.

AMPERITE CO. 561 BROADWAY
NEW YORK 12, N. Y.

In Canada: Atlas Radio Corp., Ltd.
560 King St. W., Toronto

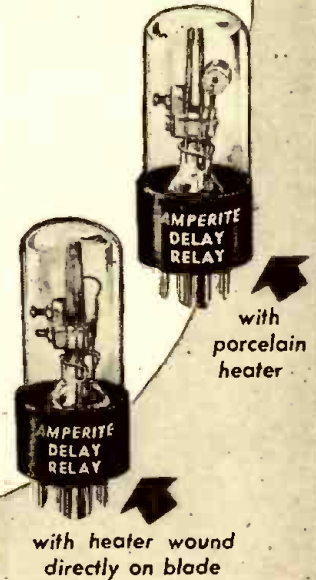

NOW AVAILABLE

Student

"MIDGET" KITS FOR AC-DC OPERATION!

The "Student Midget" Kits are now available for AC-DC operation. Similar in every respect, except for the power supply, to the battery operated models. The same progressive building idea has been maintained in making these kits available in the Two and Three tube forms—with the special Add-On kit for converting the Two tube to the Three tube set. Both kits are intended for headphone operation. Uses the same plug-in coils as the battery models. Coil for the BC band is furnished with the kit. Type 76 tubes are used throughout. One of them in each kit being used as a rectifier in the power supply. Tubes not supplied. Detailed instructions furnished.

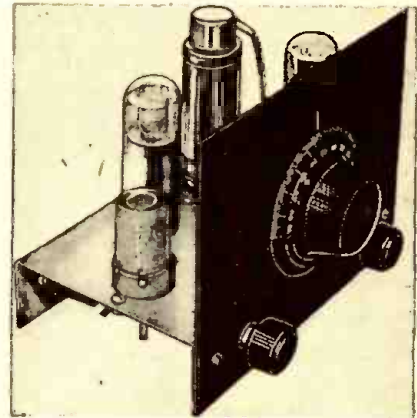

AC-DC MODELS!!!

AC-DC STUDENT KITS

No. 10-1192 Two tube Midget, Net	\$4.20
No. 10-1193 Three tube Midget, Net	4.80
ACCESSORIES		
No. 18-2940 70 to 200 meter Plug-in Coil, Net	\$0.40
No. 18-2941 35 to 70 meter Plug-in Coil, Net40
No. 18-2942 17 to 35 meter Plug-in Coil, Net40
No. 18-2944 545 to 1500 meter Plug-in Coil, Net99

Contact our nearest branch, listed below, for rapid delivery.

RADIO ELECTRIC SERVICE CO.

Main Store: N. W. Cor. 7th & Arch Sts., Philadelphia, Pa.

— BRANCHES —
PHILADELPHIA:
3145 N. Broad St., 5135 Market St.
ALLENTOWN, PA.:
1042 Hamilton St.
CAMDEN, N. J.:
513 Cooper St.
WILMINGTON, DEL.:
219 W. 8th St.

TRY THIS ONE!

HANDY TESTER

This tester is made up of parts assembled on a bakelite panel, the numbered ends of each part being connected to the prongs of an octal socket. To make external connection, a phone tip end of the cable is in-

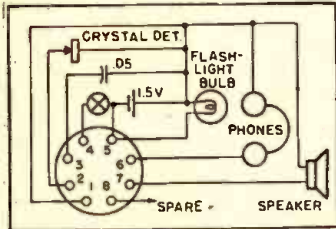

serted into the socket. The other end has a test prod.

USES

- 1 and 6. Test A.F. stages
- 2 and 6. Test R.F. stages
- 4 and 6. Test resistors
- 4 and 5. Test condensers or wire connections
- 4 and 1. Test dial bulbs
- 1 and 7. Use of test speaker
- 1 and 5. Test filament wiring. First remove all tubes, then contact test prods to filament prongs of each tube. If bulb lights normally, tubes may be inserted.

I have found this instrument very useful in making quick tests. A great advantage is that there are no expensive meters to damage or burn out.

V. EDIGER,
Rosetown, Sask., Can.

TRANSFORMER KINK

This kink may help someone who finds himself in the same position I did when one side of my push-pull transformer burned out. I rewired the cir-

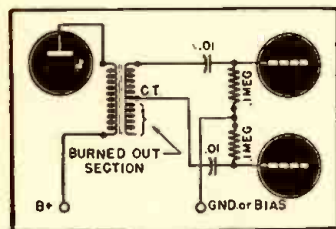

cuit as per diagram, eliminating the burned-out section.

The transformer still furnishes 180° out-of-phase signal to the output grids but at a lower voltage.

DONALD CHASE,
Winfield, Kansas.

(Incidentally, this method could be employed to use any audio transformer for push-pull input. Voltage gain and grid impedance would be low, but with present shortages, the idea might be worth while. —Editor)

364

Radio-Craft wants original kinks from its readers, and will award a seven-month subscription for each one published. To be accepted, ideas must be new and useful. Send your pet short-cut or new idea in today!

CANNED CRYSTAL SET

Most junk boxes have the necessary parts for this one. Use an old shield can (2) over which is fitted snugly the coil form (3) which has about 125 turns of No. 24 insulated wire. The form is about 2" diameter. Another shield can (1) is now fitted over the coil, so that

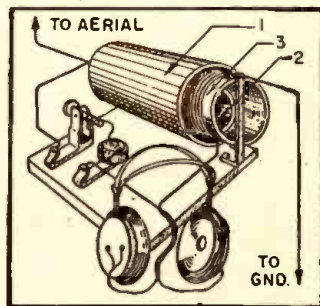

it will slide back and forth over the coil for tuning.

Use flexible wire for coil connections. Can No. 2 should be wrapped with gummed paper so as to provide a snug fit with the coil over it. I believe this design to be original.

JOHN HAYNES,
Doe Run, Missouri.

(The principle here described is that of the Capind, first described in *Radio-Craft* January, 1943. Experiment has shown that operation is improved if the shield cans are slotted lengthwise with a slot about 1/8 inch wide.—Editor)

TUBE PULLER

This puller may be used for tubes or vibrators which become stuck in their sockets. It is made from the handle of an old pancake turner.

The end is turned, filed flat and pointed as shown, so it will work under the base. This saves tubes which become loose in their

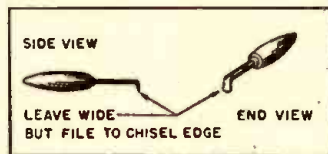

bases. After removal they may be cemented by running coil cement or thin Duco between glass and base.

EDWIN COOPER,
Independence, Kansas.

PHASE EXPERIMENTS

Here are two easily performed experiments to show the effects of an inductance and of a capacitance on lag and lead of currents.

In Fig. 1, when the switch is

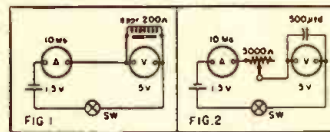

closed, the voltmeter indicates far in advance of the ammeter. The coil may be one of about 200 ohms D.C. or the secondary of a high-voltage transformer. (If a large condenser [400-700 MFD] is added in series both meters rise at the same rate, showing resonance.)

In Fig. 2 the ammeter indicates first. The condenser may be about 500 MFD, and the resistor between 2000 and 3000 ohms. A 1 1/2 volt cell is sufficient for both experiments.

J. H. SHAY,
South River, N. J.

AN H-F BUZZER

This buzzer produces an excellent high-frequency note and is not particularly difficult to construct. Any headphone unit

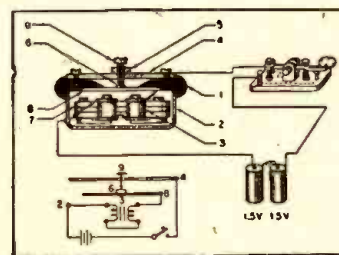

will do, though a large one will be easier to work with.

Details are given below:

1. Telephone case cover (insulated).
2. Housing.
3. Telephone coils.
4. Brass plate (app. 1/2").
5. Fixing nut.
6. Silver contact.
7. Permanent magnet.
8. Diaphragm.
9. Adjusting screw.

The diagram tells the whole story. No further instructions are necessary.

W. SNABERK,
Columbia, S. A.

TONE IMPROVEMENT

I recently came upon an old set which worked well on low volume, but distorted badly at full volume. This set used a pentode detector which was overloaded.

I changed the circuit by tying together the plate, screen and suppressor thus making a high- μ triode stage, capable of handling large input signals. The set is now able to handle full volume with no distortion. This kink may be used on 6C6, 78, 6B8, etc., type tubes with a great improvement in quality.

J. L. DUBOVY,
Bronx, N. Y.

(It is possible that the change simply lowers the set's sensitivity, making it harder to overload the tube. Have others tried this method?—Editor)

STARTER RECTIFIER

I find that a fluorescent light (gas type) starter makes a good half-wave rectifier and works well with one and two tube receivers. Mine gives 95 volts at 25 M.A.

The transformer may be of the tube-to-speaker type. I used

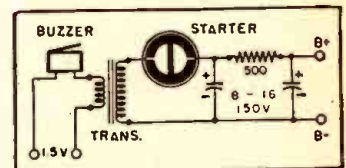

a model plane induction coil. The buzzer is of the 1.5 volt type.

RICHARD F. REED,
Jacksonville, Fla.

PILOT BULB TESTER

Using only two snap-on panel-lamp sockets and a 4-prong tube base, it is possible to make a simple pilot lamp tester.

The pilot bases (one for bayonet and the other for screw types) are wired to the filament prongs so that on inserting into any 4-prong socket of a radio or analyzer it is possible to test bulbs.

W. F. ONDER,
Kimmswick, Mo.

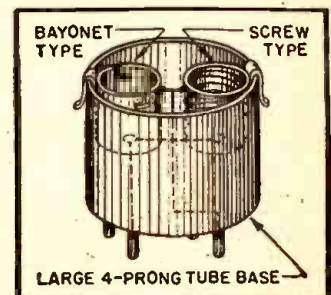

CIRCUIT EQUALIZATION

(Continued from page 348)

types of the high-mu triode variety having an amplification factor of about 70. The circuit is push-pull or balanced throughout, which keeps down harmonic distortion and hum. It has a gain of 65 VU, a maximum output level of 12 watts and its input may be operated at a level of -40 VU while still keeping a noise level of 65 VU below the output. In radio broadcasting it is possible to purchase or rent the use of an ordinary line between studio and transmitter at a cheaper rate than if an equalized line is rented and the telephone company must guarantee the response. The use of an equalizer which has a rather sharp peak in the frequency characteristic may be necessary. To alter the response of the equalizer amplifier, special feed-back networks may be employed as illustrated in Fig. 10. Several other types of networks, some of them with resistive or inductive components, may be inserted in the feed-back circuit of the amplifier. If desired, two or more networks may be used to secure the necessary operating characteristics, for

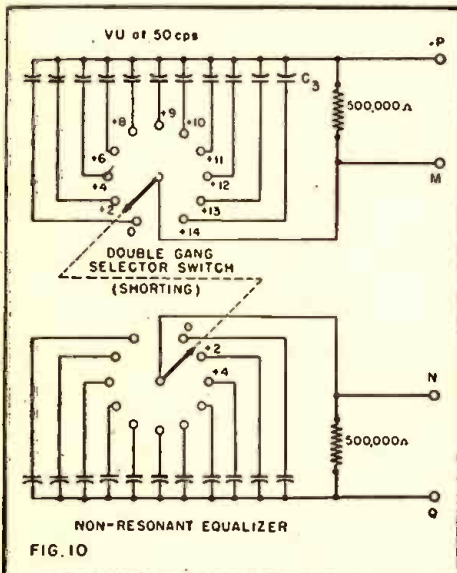

example, double-peaked responses or other special features which may be needed by particular lines.

The FCC has granted the Atlanta Journal Company of Atlanta, Georgia, a license to cover the experimental operation of portable developmental FM station W4XAJ in the Atlanta area. The grant is for 700 watts power on frequencies to be assigned by the FCC chief engineer. The licensee has been operating W4XAJ for some weeks under temporary authorization utilizing the 43,700 kilocycle frequency. It was expected that this frequency would be changed to 49,900 kilocycles.—*F.M.*

CORRECTION

In the diagram of the Valco Guitar Amplifier which appeared in the January issue on page 217, the grid resistor on the first half of VT4 is missing. This resistor should have a value of 500,000 ohms.

We are indebted to Cpl. A. Fleischhaker of Fort Dix for this correction.

RADIO-CRAFT for MARCH, 1945



Pioneers Yesterday
Pioneers Tomorrow

TURNER

Microphones



(TURNER 211)

New
TURNER 211 Dynamic
Meets the Requirements of FM

UTILIZING a new type magnet structure and acoustic network, Turner 211 has extended the high frequency range and raised the extreme lows from 2 to 4 decibels to compensate for overall deficiencies in loud speaker systems. Unique diaphragm structure results in extremely low harmonic and phase distortion without sacrificing high output level. A sensitive unit for extra intelligible sound transmission, Turner 211 has wide application in military and industrial areas, as well as for P.A. systems and broadcast studios, including FM. Write for specifications.



9X-D



22X-D

Free

Write for Free Turner Microphone Catalog giving complete information on all Turner Microphones.



Crystals licensed under patents of the Brush Development Co.

999

The TURNER Company

CEDAR RAPIDS, IOWA

THE QUESTION BOX

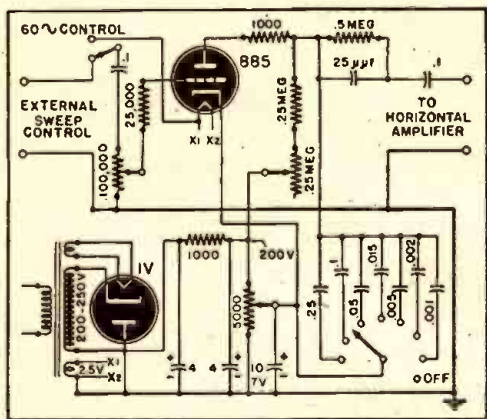

SAWTOOTH SWEEP

Q I wish to make a sweep circuit for use as the horizontal sweep of an oscillator. Please give me such a diagram using a 885 tube—B. W. J., Delta, Penn. (See diagram above)

A. This circuit is given. A 1V tube is used as rectifier to provide the high voltage. The several values of condensers are switched in to provide a wide range of frequencies.

For external sweep connection is made at the terminals provided and the switch put on "off."

A one- or two-tube amplifier is necessary to provide a large enough linear sweep. You can follow the diagram of a standard oscilloscope's amplifier.

1.5-VOLT TUBE SET

Q Please show a diagram of a receiver using the 1.5-volt tubes plus a 25Z5 for AC-DC supply. Is it possible to eliminate all batteries?—F. R. V., Elizabeth, N. J. (See diagram below)

A. Diagram and all constants are shown. Filament supply is taken from condenser C which should be at least 100 Mfd.

You might parallel several units to obtain a large value, working voltage of these condensers being 5 volts. The three stages are R.F., detector and A.F. A.V.C. is applied to the radio-frequency stage.

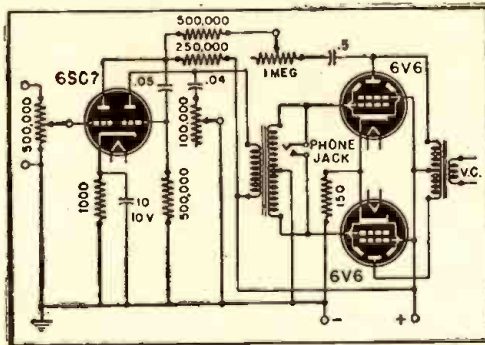
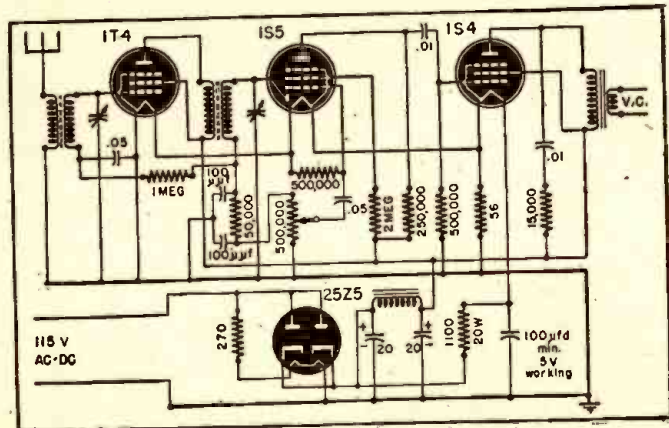

This high-gain amplifier combines resistance and transformer coupling.

A.F. AMPLIFIER

Q Please draw a circuit of an A.F. amplifier (three stages) using a 6SC7 and push-pull 6V6's. A tone control should be inserted.—J. H., Winnipeg, Canada.

(See diagram above, right)

A. As shown, the first section of the 6SC7 is resistance coupled, the second section transformer coupled to the final stage. This is necessary to provide phase inversion.

Feedback coupling has also been shown. This will result in an increase of good tone quality. The use of phones is also possible by inserting them in the jack.

WATTMETER

Q I understand that it is possible to hook up an A.C. milliammeter as a wattmeter to be used in service work. Will you please give me a diagram showing how I can use my 100 Ma meter for this purpose?—M.L.J., Sydney, N. Y.

A. The instrument you ask for is not actually a wattmeter. It is really an A.C. ammeter, and only under conditions of unity power factor and known A.C. voltage may it be said to read watts.

An old filament transformer is the best type for the instrument transformer in this circuit. The filament winding is connected in

series with the line and load—the other across the meter. The reading of the meter is simply the current drawn by the device plugged into the receptacle, divided by the transformer ratio. With a 2½-volt filament transformer your 100-Ma meter will read currents up to 4½ amperes, or approximately 500 watts.

To calibrate the instrument, it is plugged into the line and lamps of various wattages are plugged into the receptacle. A chart can then be made showing the reading for each wattage, or the meter scale may be marked directly in watts.

5-TUBE TRF

Q I wish to build a TRF receiver, incorporating an R.F. stage, a detector, A.F. and power output. The final stage should be a 6K6 with tone control.—D. H., Lachine, P. Q. (See diagram below)

A. This diagram is shown here. A sensitivity control in the form of a 10,000-ohm potentiometer is used in the first stage. This set, while sufficiently sensitive for most purposes, should give better fidelity than the usual superheterodyne, if built with high-class components.

The two tuning condensers may be ganged for convenience. Separate controls will, however, provide better sensitivity and selectivity.

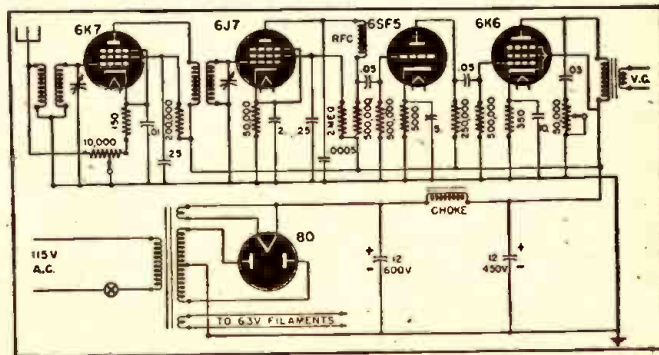

Left—The line-operated set with 1.5-volt tubes and 25Z5 rectifier. Below—A high-fidelity five-tube TRF receiver with one R.F. stage.

NEON OSCILLATOR

Q I wish to make an audio oscillator using a neon bulb. A 25Z5 is to be used as rectifier.—C. H. D., Washington, D. C.

A. The diagram is shown. A switching arrangement allows the use of different values of condensers for a wide range. The variable allows gradual change and overlapping of ranges. The 25Z5 is shown as a half-wave rectifier, and provides sufficient voltage to operate the neon bulb.

A 300-ohm resistor is used in the filament circuit.

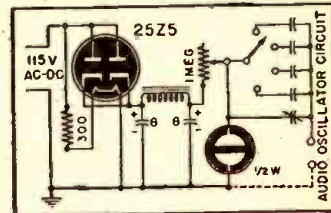

VOLTAGE AMPLIFIER

Q I am interested in a single stage voltage amplifier (AC-DC operated) for general utility. Among other uses I would like to use a carbon mike.—A. B. S., Mandeville, La.

A. We show a 6F5 amplifier and 25Z5 power supply. A final power stage may, of course, be added for speaker operation.

A carbon mike circuit is also shown. The resistance should be varied until between 5 and 10 M.A. flow through the mike. A lower value may result in less hiss.

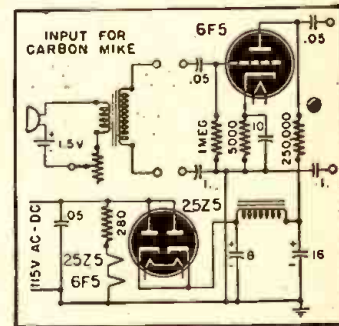

RECORDING ON A WIRE

(Continued from page 345)

wire to erase any magnetism which may be present.

The full line curve in Fig. 7 is typical for soft steel and the dotted line is that of high carbon steel, for magnetizing force vs. wire magnetization. Note the non-linearity at the origin. Due to hysteresis, the curve begins at the origin (full line) but thereafter lags behind and forms the closed dotted curve, Fig. 8. Now with the superimposition of a high frequency small closed loops will be formed between the boundaries of the large closed loops and the wire will be magnetized to an average value, because of the rapid reversals of magnetism. (Fig. 9). The curve is now linear within wide limits and high fidelity is possible. It is found that in addition the high frequency component effectively ages the magnetized wire, and greatly increases the dynamic range.

A preferred form of recording head is the construction of Fig. 10. The laminated core is made up of two pieces for convenience of manufacture and the coil surrounds the break. The pole pieces are tapered laterally on both sides and also on the underside, producing an intense longitudinal magnetic field. The air gap may be .001" to .002" for a wire diameter of .005".

In order that the wire may be replaced or removed without difficulty if necessary, a bayonet slot is built into the pole pieces. The horizontal portions of the slot are wider at the extremities so that the wire may be removed by merely twisting clockwise the protruding ends. At the same time the wire cannot accidentally leave the pole pieces during motion.

WORLD-WIDE STATION LIST

(Continued from page 357)

7.380	HER4	BERN, SWITZERLAND; off at 11 pm.
7.565	KWY	SAN FRANCISCO, CALIFORNIA; N. E. 1. Beam, 8:30 am to 12:30 pm.
7.565	WNRI	NEW YORK CITY; European beam, 3:45 to 11 pm; 6:30 to 8 am.
7.575	WLWL2	CINCINNATI, OHIO; North African beam, 3:30 to 7 pm; 7:15 to 11 pm.
7.795	—	LEYTE, PHILIPPINES; U. S. Army—heard at 4 am.
7.805	KRCA	SAN FRANCISCO, CALIFORNIA; Hawaiian beam, 11 pm to 1 am.
7.805	WRUL	BOSTON, MASSACHUSETTS; Mexican beam, 8:30 to 10:15 am.
7.820	WOOW	NEW YORK CITY; European beam, 3:30 pm to midnight.
7.86	SUZ	CAIRO, EGYPT
8.030	FXE	BEIRUT-LEBANON (SYRIA)
8.035	CNR	RABAT, MOROCCO; heard Sunday, 5 to 6 pm.
8.600	COJK	CAMAGUEY, CUBA.
8.700	COCO	HAVANA, CUBA; heard evenings.
8.830	COCQ	HAVANA, CUBA; 5:30 am to 1:30 am.
8.930	KES2	SAN FRANCISCO, CALIFORNIA; Hawaiian beam, 4:30 am to 1 pm.
8.945	COKG	SANTIAGO, CUBA; 7:30 am to 11 pm.
8.960	APH	ALLIED PRESS HEADQUARTERS IN ITALY.
8.985	COKW	HAVANA, CUBA; evenings.

Do you need BINDING POSTS?



The XL PUSH POST with its Spring Action assures Constant Contact and quick connection.

Manufactured in All Aluminum Type M at 12c each.

Aluminum Body, Bakelite Top Type B1 at 15c each.

Types CP or NP, ALL BRASS-STAIN-LESS STEEL SPRING & PIN, PROVEN by 240 HR. SALT SPRAY TEST as NON-CORROSIVE at 28c each.

Manufacturers and Dealers Liberal Discounts

X. L. RADIO LABORATORIES

420 West Chicago Ave., Chicago 0, Ill.

STAMINA



The inherent stamina of Cinaudagraph Speakers is due to experience in design and manufacturing plus highest inspection standards. In all types of Cinaudagraph Speakers, from small watch-like Handie-Talkie units to large auditorium speakers, you'll find the same precision, the same painstaking workmanship and the same long-lived faithful reproduction.

Watch Cinaudagraph Speakers after Victory!



Cinaudagraph Speakers, Inc.

3911 S. Michigan Ave., Chicago

Export Div., 13 E. 40th St., New York 16, N. Y.

"No Finer Speaker Made in all the World"

Operating Notes on

INDUSTRIAL ELECTRONICS

by Arthur G. Mohaupt, B. A., M. S.



A valuable digest of 12 lectures given to engineers and practical electronic technicians from over 50 leading manufacturing concerns. Many helpful charts and diagrams.

NOTHING ELSE LIKE IT! DOWN-TO-EARTH INFORMATION FOR THE PRACTICAL ELECTRONIC TECHNICIAN

A practical, useable **ELECTRONIC MANUAL**. A valuable aid to foremen, superintendents, engineers, electrical contractors, electricians—to *everyone* interested in Electronic Control devices. Packed with practical data on Thyratrons, Ignitrons, Electronic Lighting, Induction and Dielectric Heating; Photo Tubes, Photo Control devices, Relays and Timers, Resistance Welding Control, Electronic Motor Control, etc. Replete with charts, diagrams and timely data on the functions, installation, operation and maintenance of Electronic Control devices. **SEND FOR YOUR COPY TODAY!**

Do FOREST'S TRAINING, INC., 2531 North Ashland Ave., Chicago 14, Ill. I am enclosing \$10.00 for Arthur G. Mohaupt's "OPERATING NOTES ON INDUSTRIAL ELECTRONICS." If not satisfied, I will return book in 5 days for full refund.

Name.....
Address.....
City..... State..... RC-BM3

FADA Permanent NEEDLES



List \$1.00

Special Introductory Offer 39¢

(TO DEALERS ONLY—IN LOTS OF 6 OR OVER)

- Plays 4M Records without changing
- Better Tone Reproduction
- Help Reduce Background Hiss
- Longer Record Life

FADA OF NEW YORK

928 BROADWAY NEW YORK 10, N. Y.

Large Stock of Replacement Parts and Cabinets

REPAIR ANY RADIO

★ EASIER - BETTER - FASTER

Do you like to tinker with repairing radio sets at home or for your friends? Do you want to learn all about up-to-the-minute service methods? Want to learn how to repair any radio on the market—often without any elaborate testing at all?

Then turn to the advertisement on Page 381 for details of special combination offer on A. A. Ghirardi's MODERN RADIO SERVICING and the famous RADIO TROUBLESHOOTER'S HANDBOOK, the two most helpful books in radio history. Over 2,000 big pages of the world's most helpful and profitable servicing information for only \$9.50. 5-Day Money-Back Guarantee. You cannot lose!

CONCORD SERVICE is unsurpassed

SO SAY LEADERS OF
Industry • Wartime Agencies
Laboratories • Schools

RADIO AND ELECTRONIC
PARTS AND
EQUIPMENT

Tens of thousands of enthusiastic customers are proof of Concord leadership. We can supply you with anything from a single capacitor to complex laboratory installations. Two strategically-located Concord stores—Chicago and Atlanta—are geared for speedy action.



SENSITIVE RELAY . . .

Fully adjustable sensitive relay with 2000 ohm coil. Ideal for plate-circuit or photoelectron applications. Minimum pull-in current only 2.5 milliamperes. SPDT Contacts.

MA10-C13
Your cost, each. \$4.75

THERMAL TIME DELAY RELAY . . .

Leach Type 1054T with 375 ohm 24 volt DC coil. Delay adjustable from 20 seconds to 1 minute. 1/2" fine silver DPST contacts, normally open, will handle 50 amps at 12 volts DC, 25 amps at 24 volts DC, or 6 amps at 110 volts AC.

MA10-C12
Your cost, each. \$3.35

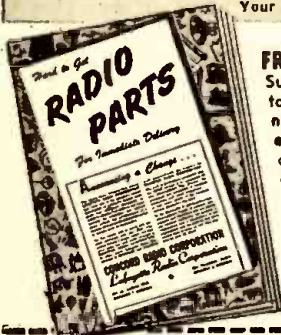

FREE! Special 16-page Supplement of "hard-to-find" and urgently needed parts and equipment. All items are ready for immediate delivery . . . but are, naturally, subject to prior sale.



MAIL THIS COUPON

CONCORD RADIO CORPORATION
901 W. Jackson Blvd., Chicago 7, Ill., Dept. RC-35
Please rush me the 16-page "Special Supplement" published by the CONCORD RADIO CORPORATION.

NAME _____
ADDRESS _____
CITY _____ STATE _____

CONCORD RADIO CORPORATION
Lafayette Radio Corporation
901 W. Jackson Blvd. 265 Peachtree Street
CHICAGO 7, ILL. ATLANTA 3, GA.

TELEVISION ADVERTISING

GROWING realization of the importance of television was shown by the National Retail Dry Goods Association, who devoted to television a complete day of their recent convention in New York City. Highlight of the day's events was an address by J. R. Poppele, president of the Television Broadcasters' Association and chief engineer of Radio WOR. Speaking on the value of the new art in retail-store advertising and demonstration, he pointed out that even the expensive and crowded convention at which he spoke might in the future be replaced by television:

"Conventions, it appears," said Mr. Poppele, "are about to become a wartime casualty. If sufficient coaxial cable and radio relay circuits as well as television transmitting and receiving equipment were now available for a national service, the convention ban might work no hardship on organizations who annually conduct their business through national conclaves.

"Supposing cables, relays and equipment were available today, as they will be two years after the war is over, the National Dry Goods Association could conduct its spring, summer and fall sessions directly via television. For example, large screen television equipment could be installed in public auditoriums in each city where Association members are located. Thus, the entire Convention program could be conducted in New York City, let us say, while members 'sit in' on the activities in their own home towns, watching the proceedings on theatre-sized screens.

"Television adds that important visual dimension to the art of broadcasting. Therein lies a great opportunity—perhaps the greatest opportunity—for a retailer to increase sales. Television takes his product right into the home and dangles it before the eyes of the shopper.

"Intra-store television is also a mighty advertising tool. Larger and brighter screens for television receivers have been developed in laboratories—I know; I've seen them. With these screens, both large and small department stores can make use of this magical medium to create immense buying appeal. Small television studios can be set up in one section of the store and screens can be prominently placed on all floors and in display windows. A demonstration or display of new goods can thus take place before hundreds of customers.

"I should like to mention a recent experience I had while attending a television demonstration. Seated about a large-screen television receiver, a small group watched images picked up by a camera in an adjoining room. The room had no special television lights—merely average room lighting—and the images were excellent. The sensitive lens also picked up some of the people seated about the television set and they could watch themselves on the television screen.

"Incidentally, I saw the back of a person's head and I remarked to the fellow next to me that the poor guy is getting pretty bald. Just then I put my hand to the back of my head and discovered I was looking at myself in the screen. All of which proves that department store beauty parlors can also make use of television!"

Although he was not aware of it at the time, he was describing an idea presented in the little Christmas booklet *Radiocracy*, issued by Mr. Gernsback late in 1943. It is apparent from the illustration that not only

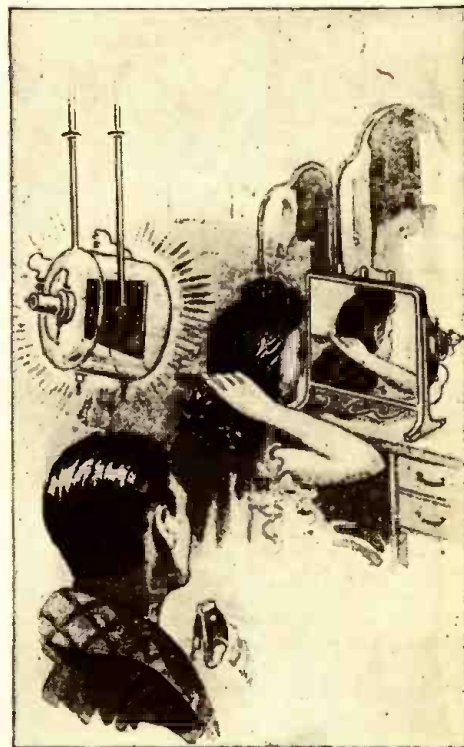

Original caption: "Hurry up with the Televator, dear, so I can shave the back of my neck."

the beauty parlor, but the average home, might be able to make good use of such a device!

"Further uses of television in department store activities are limited only by the lack of imagination of the user of equipment," concluded Mr. Poppele: "The scientific engineers of our nation have created a great instrument in television and they are now ready to dedicate it to use by department stores and by the radio industry. Here's a great opportunity, ladies and gentlemen; I hope you make the most of it."

A "sun-tan in your sedan" is the postwar aim of a Chicago company, which intends to produce an ultra-violet lamp for car use. The lamp will operate from the car's battery and may be used to sterilize the air as well as permit the riders to acquire a healthy tan, winter or summer.

"\$500 GAVE ME MY
RADIO-ELECTRONIC TRAINING!"

★ Literally thousands of today's most successful Radio-Electronic experts, and thousands more in the nation's armed forces, got their start in this fascinating field FOR A TOTAL INVESTMENT OF ONLY \$5! You can, of course, pay lots more than this—but the fact remains you can't get better, more complete, or easier-to-learn basic Radio-Electronic instruction than Ghirdi's AT ANY PRICE! What's more, you can see it, study it, and compare it before you spend a cent!

**SEE AD ON PAGE 381
SEND COUPON TODAY!**

B-29 ELECTRONIC GUNSIGHT

(Continued from page 342)

from a plane moving 250 miles an hour will be subjected to a gale of that velocity. This tends to curve the course of a bullet rearward from the plane from which it is fired. With the range 800 yards at 3,000 feet altitude, the wind will curve a bullet fired from a plane going 250 miles an hour 35 yards. Where the air is less dense at 30,000 feet, and the other elements being the same, the windage effect on the bullet would be only 12 yards.

3. *Parallax*: The gunner at his sight and the gun he is firing are a number of feet apart in this remote and central control system. Hence, the aim of the guns must be angled minutely toward the gunner's position, making up exactly for the distance between the sight and the gun at the point where the bullet meets the target. The computer makes this correction, which is almost infinitesimal and highly variable, depending on range and angle of fire.

4. *Gravity*: Gravity pulls a bullet downward. Hence it is necessary for the gun to be pointed above the target. The amount of elevation depends on range and altitude, and the gravity correction is figured by the computer. With the range 800 yards, the .50 caliber bullet will drop 4.6 yards at 30,000-foot altitude.

If these corrections were not made and the gunner fired .50 caliber guns from a B-29 going 250 miles an hour directly at the enemy plane going 400 miles an hour at 30,000 feet altitude with the range 800 yards, the bullets would go 122 yards back of the enemy plane and 4.6 yards lower than it, in addition to the parallax difference.

All of these corrections are made in the computer faster than the flick of an eyelash, they are fed by electrical impulses to the turret under the conditions described above. The guns are pointed well ahead of and slightly above the enemy plane. The actual line of fire is even a bit ahead of where the bullet and enemy plane will come together, due to the windage factor.

The turrets are equipped with fire interrupters and contour followers to prevent the guns on a B-29 from firing bullets into any part of the plane on which they are mounted. The gunner does not have to think of the danger of whirling his gun into a line that would do damage to parts of his own plane. Electric fire interrupters prevent guns from firing when pointed at any part of the airplane on which they are mounted. The mechanical contour follower is an additional safeguard which prevents guns pointing at personnel in the B-29. This is done because cartridges sometimes "cook off" in a hot barrel.

Almost overnight development and perfection of the central control system was mandatory to make possible the unescorted bombing missions by B-29's against the Japanese. The best American research scientists, aided by more than 20,000 workers in various plants, attacked this problem at the request of the Army Air Forces. How well they succeeded is not a matter for technical estimate—the news from the Far East is a more comprehensive and to-the-point evaluation of the new weapon.



Upper turret opened to show compact design.

RADIO-CRAFT for MARCH, 1945

ELECTRICITY

for Radio and Electronic Applications

ONAN ELECTRIC GENERATING PLANTS supply reliable, economical electric service for electronics applications as well as for scores of general uses.

Driven by Onan-built, 4-cycle gasoline engines, these power units are of single-unit, compact design and sturdy construction. Suitable for mobile, stationary or emergency service.

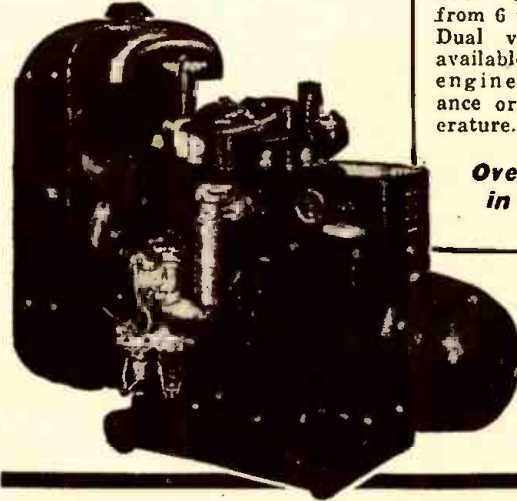

Models range from 350 to 35,000 watts. A.C. types from 115 to 660 volts; 50, 60, 180 cycles, single or three-phase; 400, 500, and 800 cycle, single phase; also special frequencies.

D.C. types range from 6 to 4000 volts. Dual voltage types available. Write for engineering assistance or detailed literature.

Over 250,000 in service

Model Shown is from W2C series, 2 and 3-KW, 60-cycle, 115 volt; powered by water-cooled, 2-cylinder engine.

D. W. ONAN & SONS 2413 Royalston Ave., Minneapolis 5, Minn.

SPEED UP REPAIRS WITH THESE G-C AIDS



FREE STEEL CABINET

G-C DIAL BELT KITS

Exact replacement woven fabric belts. Easy to install—no stretching—no adjustments—a perfect fit everytime. Kits come with 25, 50, 100, 200 or 300 belts.

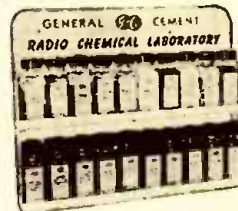

RADIO CHEMICAL LABORATORY

Twenty 2 oz. bottles. A complete assortment of cements, solvents, coil dopes, lubricants, cleaners, etc. Brushes in bottle caps. Indexed steel rack.

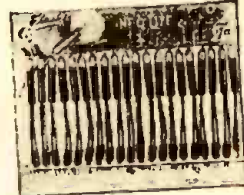

G-C NE-O-LITE

New improved design. Useful hundreds of ways. Tests AC and DC lines, DC polarity, fuses, etc. You can't afford to be without this handy all-purpose trouble shooter.

Order From Your Radio Parts Jobber
ALWAYS ASK FOR G-C PRODUCTS



GENERAL CEMENT MFG. CO.
ROCKFORD, ILLINOIS

PATENTS—TRADE MARKS

Booklet concerning Inventions & Patents Form "Evidence of Conception" with instructions for use and "Schedule of Government and Attorneys Fees"—Free
LANCASTER, ALLWINE & ROMMEL
Registered Patent Attorneys

436 Bowen Bldg.

Washington 5, D. C.

Ted McElroy

World's Largest Manufacturer of Wireless Telegraphic Apparatus

COMPLETE CENTRAL OFFICE EQUIPMENT

McElroy Manufacturing Corp.

82 Brookline Avenue • Boston, Massachusetts

6 ways to be your own boss!

NOW, more than ever before, is the right time to start a small profitable business of your own ... or train yourself for a practical money-making trade in which you can be independent. TODAY take your first step, without cost or obligation. Just mail coupon—and by return mail you will get full information on the courses listed here.

watch and clock repairing



LEARN AT HOME...
IN YOUR SPARE TIME. Prepare for a happy future of prosperity, security ... and get a big-pay job now. You can EARN WHILE YOU LEARN. Excellent field for part-time work at home. PRACTICAL

COURSE IN HOROLOGY

Thorough self-instruction training in American & Swiss watches, clocks. Special sections on alarm clock repairs. Interesting LEARN-BY-DOING instruction method. Learn QUICKLY, easily. No previous experience necessary. WATCH MAKING IS BASIC TRAINING FOR AIRCRAFT INSTRUMENT WORK and other scientific precision jobs.

Amazing Low Price! Money-Back Guarantee!
Get into this fast-growing field NOW ... big opportunity. Mail coupon below for FREE information. No obligation.

locksmithing and key making

Practical Up-To-Date Course

How to pick locks, de-code, make master-keys, repair, install, service, etc. New self-instruction lessons for every handy man, homeowner, carpenter, mechanic, service station, fix-it shop, hardware dealer or gunsmith.

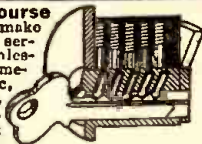

35 Easy Illustrated Lessons

Low Price! Satisfaction guaranteed or your money back. Write now ... no obligation!

practical RADIO servicing



SELF-INSTRUCTION COURSE

Teaches you the practical side of radio ... repair, adjustment, operation, alteration, trouble-shooting. No previous knowledge is necessary. Large clear illustrations, diagrams, charts, etc.

Interesting STEADY WORK

Set up a radio repair shop of your own—or prepare for booming industrial electronics. This useful, how-to-do-it course brings you all the fundamentals, including the latest methods, review questions, problems, answers. Strictly up-to-date. Low price. Send Coupon below for information!

MAIL ORDER BUSINESS

Your Big Opportunity!

84-lesson course on proved, tested, up-to-date profitable methods. Amazing treasure-house of the best mail order plans & practices. How to start your mail order business on a small one-man scale ... how to keep it growing more and more profitable month after month. Money-making FACTS! Mail coupon below for full details.



Practical REFRIGERATION



BRAND NEW STREAMLINED COURSE

for quick training. Authoritative step-by-step instruction on servicing household refrigerators ... how to install, operate, repair. Easy-to-follow illustrated directions on trouble-shooting, parts replacement, testing. Covers quick-freeze units, lockers, water coolers, freon, air-conditioning systems, etc. Unusual low price. Free details—mail coupon.

AUTO mechanics



Let this practical, low-priced course get you started in the auto repair trade. Good mechanics make big money now ... and have a great future! Self-training lessons show you exactly what to do and how to do it. Teaches servicing on all makes of cars ... adjustments, tune-ups, etc. Clearly written and illustrated by expert mechanics. Satisfaction or refund. FREE details.

Nelson Co. Dpt. 8C39, 321 S. Wabash Ave., Chicago 4, Ill.
WRITE FOR COMPLETE DETAILS ON ANY OF THESE COURSES. Just send coupon for World-Famous Copyrighted Success-Catalog—IT'S FREE! Write today.

FREE details ... mail coupon!

Nelson Co. Dpt. 8C39, 321 S. Wabash Ave., Chicago 4, Ill.
Please send me—FREE and without obligation—illustrated Success-Catalog containing information about the course (or courses) I have checked below. No salesman will call.
 Watch and Clock Repairing Practical Radio Servicing
 Locksmithing, Key Making Mail Order Business
 Practical Refrigeration Auto Mechanics

NAME _____
ADDRESS _____
CITY _____ STATE _____

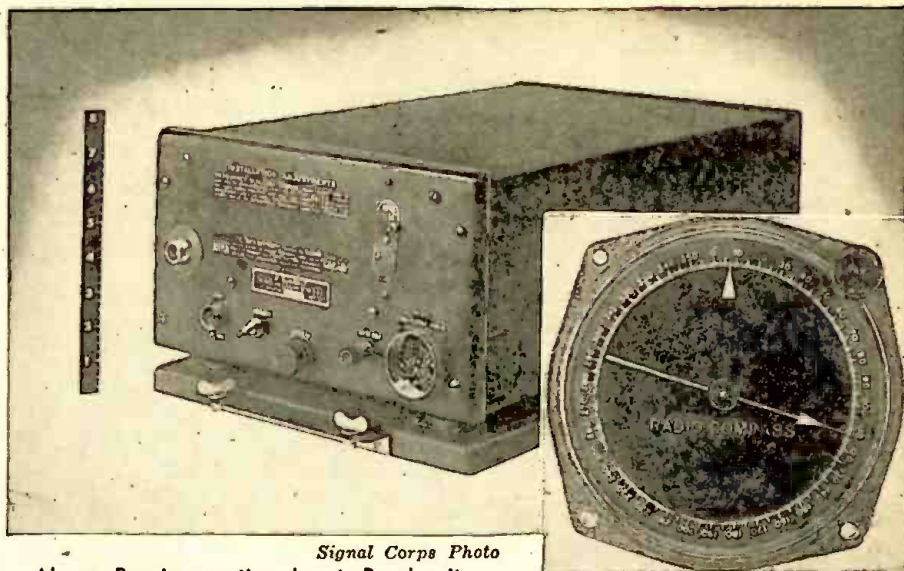

Signal Corps Photo
Above: Receiver section. Insert: Panel unit.

AUTO COMPASS AIDS BOMBING

AUTOMATIC radio compasses such as the AN/ARN-7 are indispensable aids to the navigation of fast modern Army airplanes. They permit the accurate navigation of aircraft when poor visibility or other unfavorable flight conditions preclude flying by "dead reckoning" or celestial navigation.

This radio compass may be used either for position finding or direction finding. It is a later and improved version of standard automatic aircraft radio compasses designed, developed and procured by the Signal Corps for the Army Air Forces.

When used by the crew of a plane to locate the plane's position, the set is "tuned in" to a radio station of known location. Once the radio station is identified, the bearing of the plane relative to the station may be obtained automatically. The bearings of several radio stations in a particular area are secured in rapid succession and the results plotted on a chart. The plot thus obtained by simple "triangulation" methods will show the exact location of the airplane at a particular instant of time on the map of the area over which the plane is flying.

The AN/ARN-7, being a radio compass of the automatic type, permits bearings of "fixes" to be determined swiftly thus simplifying the procedures of position finding in modern high speed bombers and transports, where a minute of time may represent many miles of space.

Where a radio station of known location lies in the path of the desired course of the airplane the AN/ARN-7 radio compass may be used to "home" on the station. The receiver portion of the set is tuned to the station's signals, and the bearing of the station with respect to the plane is continuously indicated to the pilot, either on a dial or aurally by means of signals heard in his head-phones. It is of interest to note that it is the latter use of the aircraft radio compass which is responsible for radio "blackouts" in Europe when the presence of Allied bombers has been detected by the enemy. The tuning in on the radio compass receiver of ground radio broadcast stations located in the cities that are to be bombed enables our aircraft to approach the target as directly and surely as a ship navigating toward a visible light-house.

CURE FOR CONDENSER LEAKAGE

HIGH LEAKAGE in paper condensers is often a problem, especially in humid areas. A British radioman, P. B. Stearn, writing in *Practical Wireless* (London) tells how he solved the difficulty.

"Thinking the matter over, it seemed obvious that the condensers would be usable only if the damp could be evaporated. My first experiment—in a gas oven—was a failure, for not only did the wax and pitch run out, but the cardboard containers were also charred. The condensers had a worse leak after the treatment than if they had been left alone.

"The sight of potato chips frying gave me the right idea. I selected a small saucepan and melted a quantity of paraffine wax in it, then threw in several condensers which I knew contained no pitch. After three or four minutes of energetic bubbling, the wax cleared, and after five minutes more, I removed them with tweezers. Only one unexpected thing was noted. Some of the wire ends had come unsoldered, due to the intense heat.

"On test, some of the condensers showed

a slight decrease in capacity, but on a 500-volt 'Megger' nearly an infinite resistance reading was obtained. It seems that the slight loss of capacity is caused by disintegration of the outside layers of the foil. This defect arises in only a few cases, and is not serious.

"In the second batch, I included several American midget .05 200-volts working types. After treatment, these also stood up to 500 volts test. Out of 35, only three were failures.

"For the sake of curiosity, I left two of the finished articles under water for three days. No difference in the performance was noted.

"In conclusion, I might add that this process is very handy these days. Most of the condensers sold as new are old stock and leaky."

The above method is of course useless for shorted condensers, but is apparently quite effective in the case of leakage. Mr. Stearn states that some of the condensers treated by him had a leak of 5 Ma. at 200 volts before "cooking."

SENSITIVE ALARM SYSTEM

THE protection of large areas, such as manufacturing plants, arsenals, ammunition dumps and harbors, from the intrusion of unauthorized persons is most essential in critical times. Such large areas have been guarded by microphone systems or extensive antenna systems in which a change of capacitance sets off the alarm. The former method is very expensive and responds to sounds only, while the latter is limited in extent, since the total capacitance finally becomes so great that a small increase does not operate the alarm.

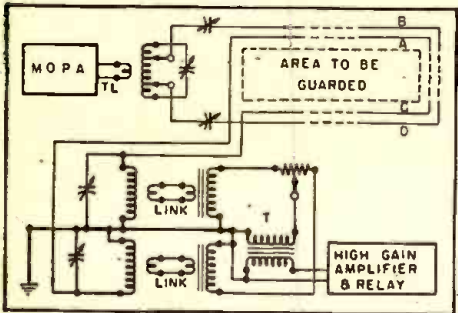

To extend the area which may be protected and also effect simplification of apparatus, J. H. Rubenstein of Syracuse, N. Y., has invented an alarm device which is efficient over areas having perimeters of thousands of feet. The device operates on a change of phase or amplitude rather than one of capacitance and is therefore extremely sensitive.

In the figure, a master-oscillator power-amplifier is coupled by a transmission line to a transformer, the secondary of which

is tuned. The two conductors B, D are fed through series condensers from the tuned circuit, which is in resonance with the MOPA. The frequency used may be in the upper audio or lower radio frequency range and must be free of harmonics. The other conductors A, C, are pick-up antennae coupled to the first two. A good arrangement is to mount all four on poles or a fence, A and C about 3 ft. from the ground, and B and D about 6 ft. from the ground. Each is, of course, insulated from each other and the ground.

Each pick-up wire is fed to a tuned circuit, and link-coupled to a bridge system, composed of two resistors and two inductances. Originally, the variable tap is adjusted for balance, that is, no current through T. Then no voltage appears at the amplifier input and the relay does not operate.

Upon the approach of a person or object, the electro-magnetic field will be distorted, changing the phase or amplitude of the picked-up voltage. The bridge becomes unbalanced, raising the alarm. The system is sensitive and stable, efficient over a wide area.—I. Q.

The General Electric Company has purchased the radio tube manufacturing and plant facilities of the Ken-Rad Tube and Lamp Corporation at Owensboro, Kentucky, and at Huntington and Rock Port, Indiana, and will take over operation of government-owned plants at Tell City, Indiana, and Bowling Green, Kentucky, where Ken-Rad has been making tubes for the government.

RADOLEK

Radio-Electronic Service Parts

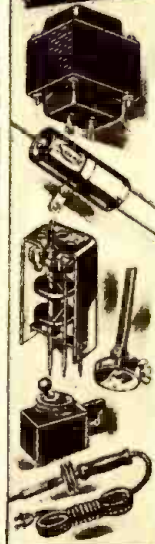

Large stocks assure the finest and most complete selections of all available items at lowest prevailing prices. Thousands of active buyers depend on us for their entire Radio repair and replacement requirements. Because we understand service problems, every order is expedited for delivery in double quick time. Everything we do is planned for convenience and satisfaction to our customers. You will find it profitable to make Radolek your buying headquarters.

FREE BUYING GUIDES

Because of existing conditions we keep our customers right up to the minute on available merchandise by releasing supplements frequently instead of sending our regular Big Profit Guide once a year. Send the coupon now to get these Free Buying Guide Supplements as they are issued.

FREE!

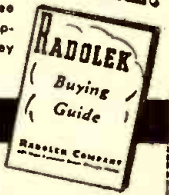

FAST SERVICE!

RADOLEK CO., Dept. C-100
601 W. Randolph St., Chicago 6, Ill.

Please send FREE Buying Guide Supplements

NAME _____

ADDRESS _____

ORDER FROM RADOLEK

FIX ANY RADIO

Amazing New Invention

Simplified Radio Servicing by Comparison Method

Find radio faults with a new simplified method. Repair radios in minutes instead of hours. Revolutionary, different Comparison technique permits you to do expert work almost immediately. Most repairs can be made without test equipment. Simple point-to-point, cross-reference, circuit suggestions locate faults quickly and easily.

COMPLETE \$1.50 ONLY
SPECIAL OFFER
READ THE DETAILS

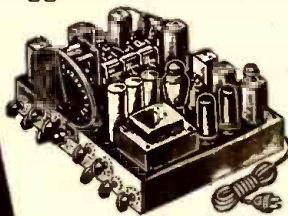

New 1945 Edition

REPAIR ANY RADIO IN MINUTES — NO TESTERS NEEDED

Learn how to locate the source of trouble in any radio without equipment. Make needed tests, measure voltage, trace the signal, by using only a resistor, small condenser, and a crystal detector. Inject signals without any signal generator. Test parts by the new Comparison method. Test tubes without equipment. Repair any radio expertly following illustrated, simplified plans. Improve your radio servicing ability. Examine and apply the plan for 10 days without obligation or risk. Send coupon today.

SUPREME PUBLICATIONS

328 S. Jefferson St. Chicago 12, Illinois

Ship postpaid the new complete Simplified Radio Servicing by COMPARISON Method manual for 10 days' examination. I am enclosing \$1.50, full price. I must be entirely satisfied or you will refund my total remittance.

NAME:

ADDRESS:

TUBES AVAILABLE

ALL INDIVIDUALLY BOXED & GUARANTEED
QUANTITIES LIMITED

Type	Net Price
6K6	\$.61
6AC561
6SA772
*6SN774
*39-4454

*6SN7 Adaptor to replace
2525—No. 1 \$.60
6SN7 Adaptor to replace
2526—No. 260
*39-44 Adaptor to replace
6K7 or 78 No. 360

Send remittance and
L-265 Cert. with order
or 25% deposit, bal-
ance C.O.D.

G.E. ALL PURPOSE FILAMENT TRANSF.

\$1.95 FOB, N. Y. Send L-265 Cert. Add Post.
Made to NAVAL SPECS. Isolantite insula-
tors at lug terminals. Pri.-115V. 5%o Cy.
A.C. Sec.—2½ V. at 5 amps.

WINDINGS—Two 5V. @ 3 amps. ea.
One 6.3V. @ 3.6 amps.
One 6.3V. @ 16 amps.

Size: 4¼ H. x 4¾ W. x 3¼ D.
Shipping Wt. 8 lbs.

RADIONIC EQUIPMENT CO.

"CHANCELLOR" PRODUCTS

170 NASSAU STREET, NEW YORK 7, N. Y.

724 OUT OF 817

★ When you want to know what is the best, most inexpensive Radio-Electronic training for you—ASK RADIO MEN! Recently, a mixed group of 817 radio men including instructors, students, repair men, radio men in the armed forces, in broadcast stations and big manufacturing plants, etc., were asked exactly what they think of the various books and courses offered for the study of Radio Electronic fundamentals. 724 of these men—NINE OUT OF TEN—wrote back that, in their opinion, a famous Ghirardi book selling FOR ONLY \$5 COMPLETE is their choice as the best buy on the market—far better than any other AT ANY PRICE!

GET THE FACTS!
SEE ADVERTISEMENT ON PAGE 381

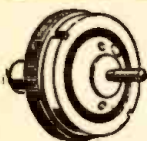

"WONDER" ELECTRIC BUTTON

Most interesting electrical apparatus ever discovered. Make your own Telephone-Amplifier. Transmit your voice or music to distant rooms. Perform hundreds of fascinating experiments. So tiny it can be concealed in dozens of places. Send \$1 now for button and free 5,000 word instruction booklet with 50 illustrated experiments. SPECIAL OFFER 6 buttons and booklets sent postpaid for \$5. Write now to
BUCK MFG. COMPANY North Aurora, Illinois

Choose the CANNON BALL



HEADSET You Like Best

Rugged construction. Inside or outside terminals. Sensitive. Clear tone. Dependable quality. Headset Headquarters guarantees satisfaction. Write for folder R-3.

Scientifically built Heavy duty magnets greatly increase their efficiency.

C. F. CANNON COMPANY
SPRINGWATER, N. Y.

Staffs for postwar television and FM stations will be available from the ranks of army- and navy-trained technicians, declared Commander William C. Eddy, U. S. Navy (retired) at the recent T.B.A. conference.

POSTWAR RADIO NEWSPRINTER

PICTURES and maps have been transmitted over wires and radio circuits for many years. Wartime has greatly accelerated facsimile transmission and excellent quality of reproduction is commonplace. The pictures are photo-electrically scanned, the impulses modulating a carrier. Upon demodulation, the impulses act upon a light source to reproduce the original image upon a photographic paper which is then processed.

ing to the received impulse. Movement from left to right and then return constitutes a complete cycle. The stylus remains at the start position until the special synchronizing signal is received to start the cycle.

The Finch "Duplex" portable machine illustrated handles 4 columns (8½" wide). It is 15" wide, 9" deep and 14" high, weighing 25 pounds complete with power supply. Scanning takes place at the rate of eight square inches per minute, 100 lines to the

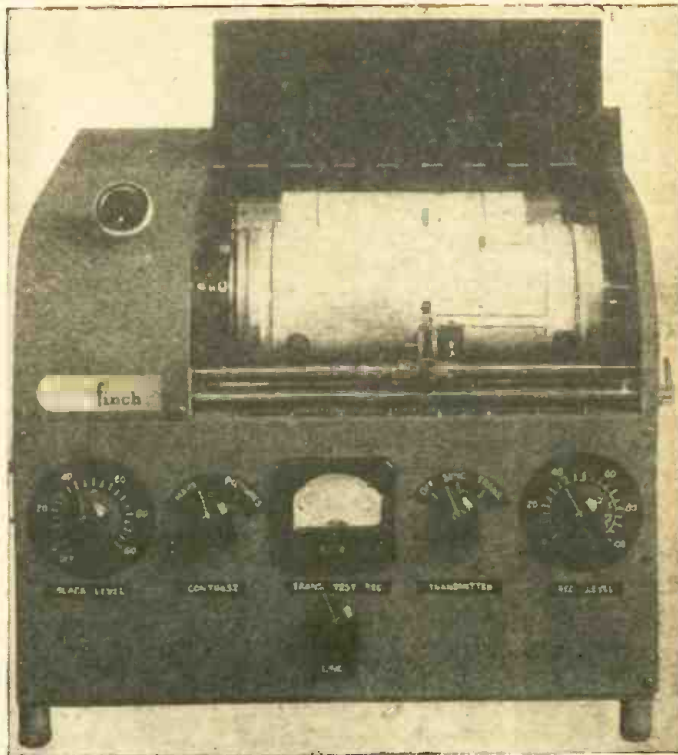

This facsimile printer operates both as receiver and transmitter. A postwar set for reception only might be smaller. It could be set at night to pick up the news broadcasts and turn out a complete and up-to-the-second newspaper in the morning.

Another facsimile system used for some time involves the use of dry electro-sensitive paper, eliminating the need for photographic processes, the picture appearing immediately. Obviously this is ideal for home reception. In addition, it may be used for police work; transmission of weather maps to ships or planes; railroad dispatching; and inter-office communication. Whereas cathode-ray television does not leave a permanent record, facsimile has this very important characteristic: It is therefore possible for an unattended machine to operate and make available a complete report during any interval.

One widely-used facsimile system is illustrated here. In Dec., 1941, over 20 broadcast stations used this system, transmitting news bulletins during the early morning hours. It is now possible to multiplex facsimile with FM sound on a single carrier, thus using no additional frequencies. Commercialization of facsimile on FM frequencies was permitted by the FCC in 1940.

Facsimile operation principles are simpler than those of television. The subject to be transmitted is clamped to a rotating cylinder. The scanning head (containing exciting lamp, photocell, lens system, carrier-modulator and amplifier tubes) moves along a lead-screw at a uniform rate. One line after another is scanned by a .01" diameter light spot, until the entire picture is complete. A similar machine at the receiver uses a tungsten wire stylus instead of the scanning head. The stylus leaves a mark on the special electro-sensitive paper, correspond-

ing to the received impulse. Movement from left to right and then return constitutes a complete cycle. The stylus remains at the start position until the special synchronizing signal is received to start the cycle.

A NEW ATOM-SMASHER

A new instrument, the spirotron, calculated to produce atom-smashing particles of even greater energy than those of the cyclotron, has been proposed by Dr. Laurence E. Dodd, associate professor of physics on the Los Angeles campus of the University of California.

Speaking at a meeting of the American Physical Society, Dr. Dodd explained how such an instrument could combine the principles of the cyclotron and the electron microscope to produce higher velocity particles than is possible with either of them.

Electrons or ions whirled by the spirotron could be made to travel at speeds above one-fifth that of light, Dr. Dodd suggested, the spirotron being particularly adapted to the production of these higher velocities.

The proposed instrument would avoid one of the limitations of the cyclotron, the need for rapidly changing frequencies. However, it has practical problems of its own, the principal one being the production of a strong magnetic field over the distance.

His suggestion for the development of the spirotron does not imply that the cyclotron has reached the limit of its usefulness, Dr. Dodd pointed out.

BLUE MONDAY WITH THE SERVICEMAN

By W. G. ESLIK

MONDAY morning, another day of wrestling radios with no holds barred, hunting parts that aren't available at the wholesale stores. We shouldn't mind that, as we tell our customers that our boys over there need the best radio equipment available and they are getting it and we can get by some way.

First set to come to the bench is a Tru-tone. D2210. The usual 12SA7 out. Looking over the stock of tubes we pick out a 14H7. Using the suppressor as the input grid and the control grid as oscillator grid with an adaptor to fit the tube to the original, the set worked fine on locals and nearby stations.

Next an old timer, a Stewart Warner 102A, with a complaint tag stating hum and weak reception. Checking filters found the two electrolytics bad. After replacing them, hum was still present. Voltages normal but noticed a positive bias on the 47. Replaced coupling condenser from 24 plate to 47 grid and hum and distortion was cleared up. Further checking revealed the 60,000-ohm 5-watt resistor from high end of volume control to B-plus was 100,000 ohms and antenna coil was open. Replacing these put another radio into operation again.

A small General Electric battery set using the 1.4-volt series tubes was changed to A.C. operation by wiring filaments in series using a 2250 ohm dropping resistor bypassed with a 100 mfd, 25 volt condenser from cathodes of the 117Z6 rectifier. A 2500-ohm 5-watt resistor was used as the filter section with 20 mfd on each side for the B-plus. Made a nice small A.C. job.

A Sheriff's car radio was next in line. A custom built Philco with a crystal hooked in the oscillator section of the 6A7. Complaint was weak reception and oscillation. By-passing the by-pass condensers with a test 1/10 mfd condenser showed the screen grid bypass to be at fault. Alignment restored the set to normal operation.

Then in came the neighbor with a Zenith minus all model numbers saying he had to have the set today as his wife was coming home from the hospital. Can't refuse a neighbor and still live in peace. It oscillated all over the dial, was weak and noisy. By using the 1/10 mfd. condenser method found a .05 mfd. open on the 6K7 I.F. cathode to ground. That cured oscillation. Alignment and replacing the 6K7 I.F. tube made another happy person and peace in the neighborhood.

A little 4-tube set bearing no name or model was then tested. The 12J7 was out. Used a 12SK7 as a replacement.

An Emerson portable had battery plugs changed to fit another battery pack and another set was checked out.

A costly record player was next. Costly, because it set the line cord on fire, burning a hole in a Persian rug and causing damage of \$200 in the home of one of our local officers. Checking found the 32L7 and line cord out. Rewired it to use a 117P7, our last tube as we use the 117P7's in changing 1.4 volt battery sets to A.C. (by wiring the 1.4 volt tube in series as the output section's cathode resistor, by-passed with a 50- to 100-mfd. condenser).

A Sonora minus model number was checked. As luck would have the 1A7 was out—couldn't be a 1N5 on a bet. A 1R5

RIDER VOLUME XIV COVERS 1941-42 RECEIVERS

FIFTEEN SILVER
DOLLARS FOR
THIS ONE...



"Fifteen silver dollars for this one..." were the first words I spoke as a new radio, four years ago. I don't remember the question, but I was thinking of those, my first words the other day when I noticed that that's the price of Rider's Abridged Manual Vols. I to V. It also occurred to me if the "Doctor" had asked "What's the best fifteen dollar investment a radio serviceman can make?" the answer would be easy.

That particular book gives the servicing data on the most widely sold sets issued between 1929 and 1935.

For sets of my age, made in 1941-42, there's Vol. XIV. This gives all the information you need to quickly diagnose and cure defects in we receivers issued during the last year and a half of civilian radio production.

If your jobber's out of a particular volume when you ask for it, please be patient. WPB paper limitations, y'know.

RIDER MANUALS (14 VOLUMES)

Volumes XIV to VII . . .	12.50 each volume
Volume VI	9.50
Abridged Manuals I to V (1 vol.)	15.00
Automatic Record Changers and Recorders	7.50
OTHER RIDER BOOKS YOU NEED	
The Cathode Ray Tube at Work Accepted authority on subject	4.00
Frequency Modulation Gives principles of FM radio	2.00
Servicing by Signal Tracing Basic Method of radio servicing	4.00
Servicing Superheterodynes	2.00

The Meter at Work An elementary text on meters	2.00
The Oscillator at Work How to use, test and repair	2.50
Vacuum Tube Voltmeters Both theory and practice	2.50
Automatic Frequency Control Systems —also automatic tuning systems	1.75
A-C Calculation Charts Two to five times as fast as slide rule	7.50
Hour-A-Day-with-Rider Series— On "Alternating Currents in Radio Receivers"— On "Resonance & Alignment"— On "Automatic Volume Control"— On "D-C Voltage Distribution"	1.25 each

JOHN F. RIDER PUBLISHER, INC. 404 FOURTH AVE., N.Y. 16, N.Y.

Export Division: Rocks-International Corp. 13 E. 40th Street New York City

Cable: ARLAB

RIDER MANUALS *are complete* IN 14 VOLUMES

was used to replace the bad 1A7. Worked as well as the 1A7, when the mouse-chewed oscillator coil was replaced.

Next was the old Majestic 15, local reception only. Autodyne detector wasn't working. Replaced the 10,000-ohm cathode resistor with a 7500-ohm, and it went back to normal operation.

Decided to call it a day and try to find out what 3 dozen 12SL7's were good for besides 35Z5 and other rectifier replacements.

When the hurricane of October 18 and 19 temporarily halted practically all long distance telephone service into Miami, Florida, by causing several breaks in the St. Augustine-West Palm Beach line, overseas radiotelephone facilities were called upon to handle calls between New York and Miami for five hours during the evening of October 19.—*Long Lines.*

HOW TO TEST A RADIO IN 2 MINUTES or less!

★ Want to learn to repair your own radio sets at home? Want to repair sets for neighbors and friends? Or, if you are already a radio serviceman, do you want to learn how to diagnose radio troubles and fix sets **TWICE AS FAST AND TWICE AS PROFITABLY**—without a lot of unnecessary testing?

Of course you do! Turn to advertisement on Page 381 of this issue and see how A. A. Ghirardi makes all of this—and much more—possible for the amazingly low sum of only \$5!

**ABSOLUTE
MONEY-BACK GUARANTEE!**

MODEL 504-A

Tube and Set TESTER....

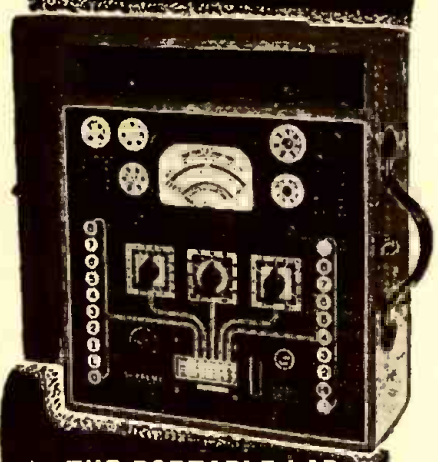

★ THE PORTABLE LAB THAT GIVES YOU— Everything!

- ★ Design proven by over 5 years production of thousands of this model.
- ★ Operation as simple as ABC. Multifunction push-button switches do all work. Simply "follow the arrows" for tube checking. No roaming test leads for the multi-meter.
- ★ Open face wide scale 4 1/4-inch rugged meter built especially for this tester—500 microampere sensitivity.
- ★ Each AC and DC range individually calibrated.
- ★ Professional appearance. Solid golden oak carrying case.
- ★ Guaranteed Rectifier.

SPECIFICATIONS

- DC MICROAMPERES: 0-500
- DC MILLIAMPERES: 0-2.5-10-50-250
- DC AMPERES: 0-1-10
- DC VOLTS—1000 OHMS PER VOLT: 0-5-25-100-250-500-1000-2500
- AC VOLTS: 0-5-10-50-250-1000
- OUTPUT VOLTS: 0-5-10-50-250-1000
- OHMMETER: 0-200-2000-20,000 OHMS 0-2-20 MEGOHMS
- BATTERY TEST: Check Dry Portable "A" and "B" Batteries Under Load
- CONDENSER CHECK: Electrolytics checked on English Reading Scale at Rated Voltages of 25-50-100-200-250-300-450 Volts.
- TUBE TESTER: Emission type with noise test, floating filaments, easy chart operation. Checks all receiving type tubes.
- POWER SUPPLY: 115 volts 60 cycle. Special voltage and frequency upon request.

SUPREME

SUPREME INSTRUMENTS CORP.
Greenwood, Miss., U.S.A.

Progress in Invention

Conducted by I. QUEEN.

ICE DETECTOR

Patent No. 2,359,787

THIS device detects ice formation upon a surface such as aircraft wings, and automatically operates ice-melting apparatus. A glass prism P is built into the wing-surface S, a bulb B passing a light beam through it.

From Snell's Law, a ray at the surface between two media is passed on unless its angle of incidence is greater than a given critical value. Without the ice layer I, the light is reflected as shown in the diagram, because the critical angle from glass to air is $43^{\circ}2'$ and the ray always strikes the top surface of the prism at a 45° angle.

The critical angle between glass and water is 70° , so when ice forms, the light ray passes through the prism and does not strike the photocell. In the latter case no bias potential is generated at the tube grid and a large plate current operates the relay, passing current from the generator G to the heating resistors. The meter M may be used as an indication of ice. This invention was patented by Melville F. Peters, Beltsville; John P. Boston, Garrett Park, Md., and Henry M. Taylor, Dayton, Ohio.

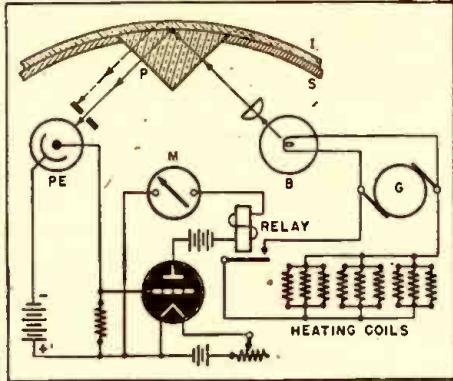

QUICK RESPONSE METER

Patent No. 2,356,617

THIS idea, patented by Theodore A. Rich of Schenectady, N. Y., speeds up the indication of normally sluggish meters. A condenser of about 0.1 mfd. capacity is placed across the external series resistor. The initial rush of current through C brings the pointer quickly to its correct indication. Should the voltage decrease suddenly, C discharges at once and again the pointer follows quickly. An initial heavy current starts the pointer and the final dip damps it at full reading.

The graphs show: A, resistor current; B, condenser current; C, their sum.

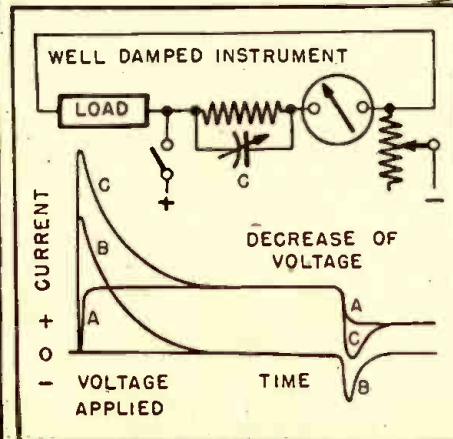

DETECTOR CIRCUIT

Patent No. 2,361,616

THIS circuit overcomes previous limitations of diode detectors and provides greater sensitivity and selectivity. A diode usually loads the circuit while an infinite impedance type does not provide sufficient AVC.

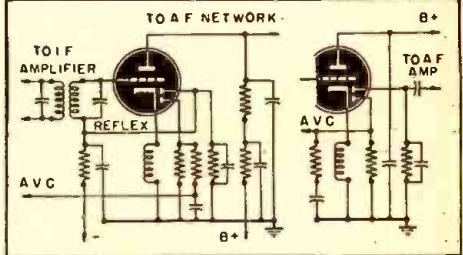

Chief feature of the new detector, developed by Frederick C. Everett, Brecksville, Ohio, is an inductance in the cathode circuit. Signals on the grid cause the tube's space current to fluctuate, producing a varying voltage across the coil. Since the voltage between diode plates and ground is constant, the varying voltage of the cathode will cause rectification in the cathode-diode circuit.

The input grid circuit is not loaded with current flowing in the diode circuit, as is the case where the diodes are attached directly to the input coil. Advantage is also taken of the tube's amplifying action.

The circuit may be hooked up in the fashion of a straight impedance detector, with one of the diodes leading to an audio amplifier, and the plate connected directly to B plus with a large by-pass condenser to ground.

A more interesting circuit is the one shown in the figure. The rectified signal is reflexed back to the grid and amplified at audio frequency.

MODULATION INDICATOR

Patent No. 2,362,830

MODULATION measurement is essential in radio telephone and modulated signal generator work. This invention, due to Halsey W. Kline, of Schenectady, indicates continuously.

The two diodes may be a single 6H5 tube. One rectifies the signal so that across C_1 there appears

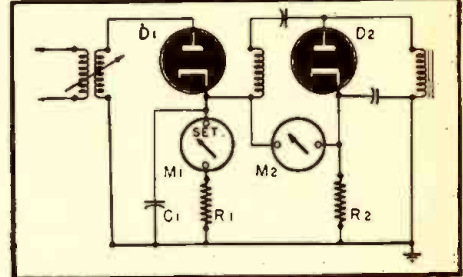

the carrier component modulated by the audio. The D.C. milliammeter M_1 in series with R_1 measures only average voltage which is proportional to the carrier strength, regardless of modulation.

The audio component is impressed on the second diode (through the R.F. filter) and the rectified and filtered voltage appears across R_2 . The high resistance D.C. voltmeter, M_2 , is connected such that it measures the difference of the voltages across the two cathodes, that is, the difference between the carrier and the modulation voltages.

At 100% modulation the two voltages are equal, so the meter reads zero. At smaller percentages the A.F. is less than the R.F., and M_2 reads upscale. The coupling to the input must be adjusted so that M_1 always reads the proper setting as determined by previous calibration.

is flown toward the luminous lines. Duplication of the horizon bar on the cathode-ray tube was relatively simple. A luminous line was made to have a universal motion up or down for dive and climb and tilting for banking indication. The directional gyro was made to control a vertical line moving laterally right or left to indicate amount of change of azimuth. The directional indication shows only a limited segment of azimuth, plus or minus 20° having been chosen. It is necessary to set in large changes of course by hand in order to centralize the azimuth indication.

For flying a definite path, additional indications must show the location of the airplane with respect to the path. In blind landings this is the principal function of the instrument. To add path location without confusing it with the attitude indications, a circle was selected as the indicator. It is so arranged that it may be deflected to the right or left by departure from a radio localizer path, and up or down to indicate departure from the radio approach glide path. The circle can move anywhere over the face of the instrument, but it must be brought to the center of the screen for normal or on-course indication. The path location circle can be made to indicate from a choice of several position-indicating instruments. In cruising flight, for example, it is deflected up or down by the barometric altimeter and thus indicates level flight. When the new visual VHF ranges are installed along the airways, the horizontal component of the motion of this circle will serve admirably to indicate the position of the beam, and the two motions will combine to indicate flight path.

Air speed is shown by a short horizontal line which rises across the face of the instrument with increasing air speed. When this air speed line is at the middle of the face, air speed is normal. As the line sinks toward the bottom of the face, stalling conditions are approached. For marker information, either for route flying or instrument landing procedure, two marker lights are provided which are mounted above and to the left and right of the cathode ray tube screen. A ball bank indicator is placed just below the cathode ray tube screen.

The pick-up device for the Flightray is an application of the miniature Telegon A.C. Selsyn, developed recently for remote indication purposes by the Kollsman Instrument Company. This same device is attached to each instrument and a balanced rectifier delivers the necessary voltage to a vertical or horizontal amplifier. The Telegon, being small and light, is readily applied to existing flight instruments. Because the device operates at low audio frequencies, placement of signal instruments is unrestricted by lead length. These instruments can therefore be located anywhere on the aircraft. This condition is also true in the British system. Freedom of apparatus location permits the signal instrument to be mounted on the flight panel, where they serve to prevent duplication of flight instrument equipment on board the aircraft. Being entirely unaffected by the addition of the pick-up device, they then become stand-in instruments. The primary instruments are provided with setting dials, thus allowing the entire flight picture to be set up on the instrument panel just as is done with the automatic pilot.

The cathode-ray power supply is unusual in that a high impedance source of D.C. at 2000 volts is required. This voltage is ob-

tained from a small dynamotor running from the aircraft's normal 12- or 24-volt battery system. The dynamotor does not supply the high voltage directly, but supplies an alternating current which is then transformed and rectified for the operation of the CR tube. The same dynamotor also supplies D.C. for the amplifiers as well as A.C. for drawing the various pattern lines and includes the commutator for switching the traces on the cathode-ray tube screen. Total power requirements are in the neighborhood of 100 watts.

Much effort has been expended on the search for a development of a satisfactory means of commutating the four pattern signals. These patterns are placed on the

screen in sequence at a rate well above the threshold of visible flicker. But since this threshold increases in frequency with increased pattern brilliance a commutation rate of at least 60 cycles is desirable. In order to secure 60-cycle commutation a mechanical switch, built into the dynamotor, provides both commutation and return-trace blanking voltages.

The Sperry Flightray has been in experimental use for several years, and while it is not likely to be commercialized, at least in its present form, has supplied much data useful in the design of future electronic aviation instruments. The Universal Flight Attitude instrument is not yet in actual use.



WE'VE GOT THOSE HARD TO GET RADIO PARTS!

QUICK SERVICE!

Our central location in the heart of the nation makes it possible to give you quicker service.

In these days of scarcity we have done everything possible to bring you the best in radio parts and equipment. In spite of existing shortages we have made available thousands of items as shown in our printed circulars.

We are determined to give you the same quick service on "hard-to-get" parts as thousands have enjoyed in the past. Because parts move so rapidly these days we intend to continue our policy of publishing an up-to-date list of merchandise every two or three months.

As additional equipment is released, we will be the first to have it. If you are not on our list to receive our flyers—mail the coupon today.

Sincerely,
Leo E. Ferguson
W9GFQ

WE SPECIALIZE IN HALLICRAFTERS

Service men all over the world are learning that the name "Hallcrafters" stands for quality in radio equipment. For many years we have been one of the country's largest distributors of Hallcrafters—"the radio man's radio." We have Hallcrafters available for immediate delivery on priority. For full particulars, write us today.

WHOLESALE RADIO LABORATORIES

744 WEST BROADWAY COUNCIL BLUFFS, IA.

SEND FOR OUR LATEST FLYER TODAY!

You'll be surprised at the many hard-to-get parts we've been able to get for you fellows—Mikes, pickups, multimeters, meters and many other items. They're yours as long as they last. Send for latest flyer. It's full of merchandise you've been trying to get! Stocks won't last long, so write today.



OUR LATEST GET-ACQUAINTED OFFERS

TUBE AND CIRCUIT REFERENCE BOOK

Here's a handy reference book that meets the demand for simple, easy to understand data on substitution of radio tubes. Contains valuable technical information on tubes and circuits. It's a guide you'll refer to time and again. Send for your copy today! Only 10c postpaid.



TUBE-BASE CALCULATOR ONLY 25c

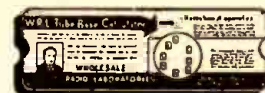

Here's just the calculator you've been looking for! Tells you quickly, tube characteristics that enable you to substitute available tubes for those hard to get. Only 25c. We pay shipping expense.

Giant Radio Reference Map - 15c



Time zones, amateur zones, short wave stations. Other valuable information. Printed in colors; size 3 1/2 x 4 1/2 ft. It's yours! Send 15c to help with packing and mailing.

Mail Coupon Today

Wholesale Radio Laboratories RC-3
744 West Broadway
Council Bluffs, Iowa

- Send your Reference Book, "Tubes and Circuits." Here's my 10c.
- You bet I want a Tube-Base calculator. 25c is enclosed.
- Ship me your free radio map. 15c is enclosed for packing and mailing.
- Send your free flyer of hard-to-get radio parts.

Name

Address

Town State

DEALERS

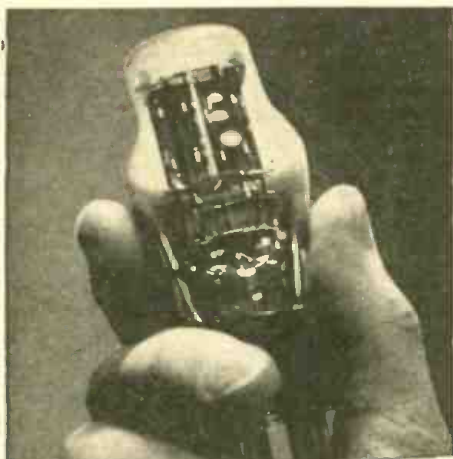

STOP!
don't
throw it away!

Let **RTS** reprocess
your dead

RADIO TUBES

NEW Scientific Process

**REACTIVATES THORIUM
CONNECTS OPEN FILAMENTS
CLEARS SHORTS and
MICROPHONICS**

(NOT the old "flash" trick)

MINIMUM ORDER 6 TUBES

SEND NO CASH

50¢ EA.

C. O. D. ONLY 1 volt & 3- ϕ 5 \$1.00

30-Day Guarantee.

Every tube fully tested in checkers & sets before playing

APPROVED BY OPA

Send itemized list with order

Make sure glass, base & prongs are intact... flashed, exploded or open cathodes **REJECTED** and **NOT RETURNED**

RTS RADIO TUBE SERVICE CO. INC.

6805 20th Avenue, Brooklyn 4, N.Y.

Available Radio-Electronic Literature

Manufacturers' bulletins, catalogs and periodicals.

A NEW SERVICE FOR RADIO-CRAFT READERS: In order to save your time, postage and incidental work in writing a number of letters to different manufacturers to secure the various bulletins offered, proceed as follows:

On your letterhead (do not use postcards) ask us to send you the literature which you designate. It is only necessary to give us the numbers. We will then send your request directly to the manufacturers, who in turn will send their bulletins or other literature directly to you.

117—ELECTRONIC RELAY CR7511-A.

A General Electrical Control. An 8-page booklet describing the operation and applications of the CR7511-A relay. The device uses an electronic tube, permitting a high-resistance path in the activating circuit, while assuring positive relay action. It is therefore especially adapted to applications where the contacts are subject to rise in resistance due to corrosion, dirt, lint or other causes.—*Gratis.*

118—REGULATED POWER SUPPLY.

Issued by Harvey Radio Laboratories. A 4-page folder describing the Harvey regulated power supply, an instrument designed to supply a regulated DC voltage of between 200 to 300 volts. With graphs showing output voltage against line voltage and against output current.—*Gratis.*

119—SOLAR PREFERRED TYPE CAPACITORS.

And Wartime Civilian Radio Maintenance with Solar "Preferred-Type" Capacitors. Issued by Solar Capacitor Sales Corp.

The first title is a 4-page folder listing "Scaldtite" and "Minicap" capacitors. The second, also a 4-page folder, describes methods of making replacements when the voltages are higher than the ratings of available replacement condensers. Methods of finding surge voltage are given, as well as formulas for condensers in series and parallel, and an electrolytic replacement chart.—*Gratis.*

120—NORTH AMERICAN PHILIPS CO., INC.

A booklet intended to serve as a general introduction for the company—newly founded in the United States—and its products. Describes briefly the work of the parent company in Holland, the formation and extent of the North American branch, with photographs of its plants, and outlines the products being manufactured by the company in North America.

There is also a brief history of Philips achievements in electronics, metallurgy, plastics and glass manufacture. A 24-page, 8 x 10-inch booklet.—*Gratis to interested parties.*

121—RCA, WHAT IT IS, WHAT IT DOES.

Issued by the Radio Corporation of America. A brochure of 41 pages, 9 x 11 inches, describing the RCA and its work. It is divided under 9 heads: Radio Corporation of America, Research and Engineering, Pioneering, Broadcasting, Television, Manufacturing, Communications, Marine Radio and Technical Training.

An interesting book describing the main features of the RCA Laboratories, the National Broadcasting Co., RCA-Victor, R.C.A. Communications and the Radiomarine Corporation of America. Well-written and profusely illustrated, this exposition will be of value to all who are engaged in any branch of radio.—*Gratis.*

122—UNIVERSAL STROBOSCOPE.

Issued by Universal Microphone Co. A six-inch cardboard stroboscope usable for checking the speed of all types of

phonographs. Patterns are provided for 78 and 33 $\frac{1}{3}$ revolutions per minute and for either 60, 25 or 50 cycles. Useful to anyone who owns a phonograph. Supplied in a folder which contains instructions on operating the device.—*Gratis.*

123—K. METHODS.

A handbook dedicated to greater efficiency in wiring for electronics. Issued by American Phenolic Corporation (Ampphenol). Correct methods of handling multi-wire cables, including high-frequency cable. Correct soldering, clamping and crimping methods and the use of the company's fixtures are covered. 6 x 9 inches, 26 pages.—*Gratis.*

124—OAK RADIO AND ELECTRICAL PRODUCTS.

Engineering and Data Sheets. Issued by Oak Mfg. Co. A 60-page catalog listing Oak switches, variable condensers, vibrators and relays, with blueprints showing their exact dimensions and giving mounting information when necessary.—*Gratis to interested parties.*

125—KEN-RAD ELECTRON TUBES.

Essential technical data on receiving and transmitting tubes, cathode-ray tubes and tubes for special purposes. An 8 $\frac{1}{2}$ x 11-inch booklet with 14 pages of tabular data covering the present Ken-Rad line. Another 6 pages are devoted to outline drawings of the various tube types, and a further 4 pages to base connections. The base connection drawings are very clear, each one occupying a one-inch square.—*Gratis.*

126—HANDBOOK OF TUBE OPERATION.

Issued by Federal Telephone and Radio Corporation. The purpose of this handbook is to develop among broadcast technicians and others who use transmitting tubes, a broader technical understanding of their characteristics, functions and applications, to the end that these critical tubes may be able to operate more efficiently and have a longer life—very important points under present conditions. 65 pages.—*Gratis to interested parties.*

127—HARD TO GET RADIO PARTS (for immediate delivery).

A catalog supplement by the Concord Radio Corporation (formerly Lafayette Radio Corporation). Supplement No. 97, a 16-page catalog of radio parts.—*Gratis.*

128—RADIO AND ELECTRONIC BOOK GUIDE.

Issued by Allied Radio Corporation. A small (3 x 6-inch) catalog of books on radio and allied subjects, covering most of the titles in publication on these subjects.—*Gratis.*

129—RAYTHEON TUBE DATA AND SUBSTITUTION CHART.

A 44-page booklet carrying technical data on Raytheon tubes, including hearing-aid types, special tubes and panel lamps. The last ten pages are devoted to information and charts on tube substitutions.—*Gratis.*

during the positive signal alternations, since none is able to flow during the negative peaks due to the high negative grid bias. Therefore, the wave-shape of the plate current variations is definitely not a true reproduction of the input signal. However, this excessive harmonic distortion may be minimized in the output by providing a parallel-resonant "tank" circuit, or by operating two tubes in push-pull.

The tank circuit inertia established by virtue of the kinetic energy stored in the electromagnetic and electrostatic fields tends to keep the circuit oscillating. When a positive peak of the incoming signal alternating E.M.F. is applied to the grid of the tube, plate current flows, and a voltage is therefore developed across the tank circuit impedance. As soon as the positive peak of the plate current begins to diminish, the condenser discharges through the inductance, and the energy developed in the inductance by the increasing and collapsing field recharges the condenser in the opposite direction, thus completing the cycle. The tank circuit presents a fairly low impedance to the second and higher harmonic components of the plate current. Thus they are shunted through to ground and only low voltages at these frequencies appear across the load.

The operation of a push-pull Class B linear amplifier is illustrated in Fig. 3. It is seen that the resultant plate current drawn by the two tubes is very nearly a linear reproduction of the grid-voltage swing. The load impedance is designed for maximum transfer of energy to the output

($Z_L = Z_p$). Under these conditions, the power output is proportional to the square of the excitation. Thus the peak power at 100% modulation is four times that at zero modulation, and the steady power output is $1\frac{1}{2}$ times that of zero modulation. Therefore, as compared with a Class A power system, Class B operation exhibits the advantages of higher efficiency and a practically negligible loss in power when no signal is applied.

However, for a minimum of distortion, it is very important that the ideal operating conditions be realized. When adjusting a push-pull linear amplifier, the two tubes must be very closely balanced; i.e., both sides of the circuit should have very nearly equivalent operating conditions as regards grid swing and circuit adjustment, so that symmetrical plate currents flow in the individual tubes. A difference of only 10% in the plate currents will result in 5% second-harmonic distortion. The load impedance must also be designed and adjusted so that it maintains its proper value throughout the operating frequency range. The excitation, furthermore, must be of the proper amplitude at all times. These disadvantages, however, are outweighed by the advantages in broadcast operation, where the equipment is under the constant supervision of a transmitter engineer.

Recent developments have caused the Class B amplifier to be largely supplanted by the Class C amplifier, which will be covered next month. Also to be discussed are the reasons for and methods of R.F. amplifier neutralization.

A WIREMAN'S SERVICE KIT

RADIOMEN have been looked upon with a certain amount of friendly contempt by their brothers of the electrical wiring and wire communications world. Reason: workmanship! The radioman usually fastens two wires together so they'll stick, but often without benefit of the polished Western Union style. Same thing in house wiring. If a doublet lead is to be carried around the walls of two rooms to the receiver, our radio serviceman can get it there, but his job would seldom be con-



A complete portable workshop is this "K" carrier service kit used by servicemen of the A. T. and T.

RADIO-CRAFT for MARCH, 1945

fused with "interior wiring." (As a matter of fact, some very successful radiomen use the local electrician for such jobs.)

The wireman, on the other hand, realizes that the appearance of his job is an important feature, and turns out his work both well-done and well-finished.

In one branch the radioman has always held pride of place. The instruments he uses are infinitely more neatly packaged, finished in appearance and expensively adapted to their work than the test instruments used by other branches of the electric service game—the crude bell and dry cell of the electrician or the rough "megger" carried by the communications man.

Now it almost seems that the radioman will have to yield on this point as well. The test kit illustrated, which is supplied by American Telephone and Telegraph Co. to some of its servicemen, can compare with the best radio test equipment. One of the meters is easily recognizable as an ordinary multitester—the other looks like a multi-range voltmeter. The provision for tools in the lid is a great improvement on the simple "tool compartment," as tools are kept in order and are easy to get at. Sockets around two sides are ready to hold standard-size screw-top bottles which hold small parts, oils, etc.

But that's not all there is to the story. This complete kit was devised to service one piece of equipment—the "K" carrier amplifier. When radio service work becomes as highly specialized as this, we can expect the radioman to develop his own kit as streamlined as the one shown—with a few hook-on adapter plugs in addition.



10,000 PARTS immediately available on priorities.

SAME-DAY SERVICE

Trained expeditors fill your order the day we receive it.

SINCE 1922 we have been known as reliable and responsible jobbers, wholesalers and manufacturers, of radio and electronic equipment.

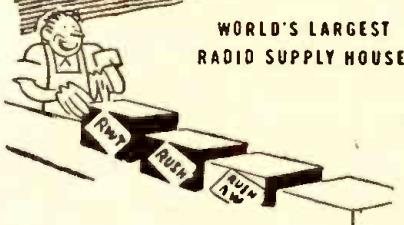

Originators and Peacetime Marketèrs of the celebrated

Lafayette Radio

Write today for our bargain flyers and special bulletins.



MR. RADIO

You Can Use
These
"Tools"

—To Build a Better Job and a Secure Career in RADIO-ELECTRONICS

CREI Home Study Training in Practical Radio-Electronics Engineering Combined With Your Own Experience Assures You of Post-War Security and an Interesting Profitable Career.

But, you won't be able to merely step into the job of your choice. After the war, it will be "the survival of the fittest." Employers will once again be "choosy." Only the best qualified men will be selected for the best jobs.

NOW is the time to take the time to prepare yourself for these important, career jobs in radio-electronics engineering. CREI can show you the way by providing you with the "tools" to build a firm foundation of ability based on a planned program of technical training.

In our proved home study course, you learn not only how... but why! Easy-to-read-and-understand lessons are provided you well in advance, and each student has his personal instructor who corrects, criticizes and offers suggestions on each lesson examination. This is the successful CREI method of training for which more than 10,000 professional radiomen have enrolled since 1927.

Investigate now the CREI home-study course best suited to your needs, and prepare for security and happiness in the coming New World of Electronics! Write for all the facts now.

● WRITE FOR NEW, FREE 36-PAGE BOOKLET

If you have had professional or amateur radio experience and want to make more money—let us help you qualify for a better radio job. TELL US ABOUT YOURSELF, so we can intelligently plan a course best suited for your needs.—PLEASE STATE BRIEFLY YOUR BACKGROUND OF EXPERIENCE, EDUCATION AND PRESENT POSITION.



CAPITOL RADIO ENGINEERING INSTITUTE

Home Study Courses in Practical Radio-Electronics Engineering for Professional Self-Improvement

Dept. RC-3, 3224—16th St., N. W.
WASHINGTON 10, D. C.

Contractors to U.S. Navy—U.S. Coast Guard
—Canadian Broadcasting Corp.—Producers of
Well-trained Technical Radiomen for Industry

SPEECH AMPLIFIER

(Continued from page 354)

any place along this resistor is of the same phase as the voltage on the grid of T_3 and is proportional to the grid voltage. Since it is normal for T_1 and T_2 to be identical tubes their gains will be equal and it is necessary for the input voltage to both tubes to be equal in order that their outputs will be equal. We may consider the voltage input to T_1 as being e_a . It is then necessary for the input of T_2 to be of the same value. This value may be obtained by adjusting the relationship between R_3 and R_4 . If each of these tubes has a voltage gain of 20, the voltage across R_3 - R_4 will be equal to $20e_a$. The value of R_4 would be computed from the equation $R_4 = R_3 \times R_1/20$ (VG).

The resistors chosen for R_3 , R_4 and R_5 should be as near the correct values as possible. The adjustment of R_4 should be made under operating conditions. This is done by connecting the push-pull tubes in "push-push", i.e., the grids in push-pull and the plates in parallel, and with the amplifier working at full gain there should be no noticeable audio output. This is because when the grids are fed with equal voltages 180 degrees out-of-phase there will be zero change in the plate current, hence, no signal. This circuit will serve quite efficiently if it is correctly balanced. Since its gain is high, it is often used in portable music instrument amplifiers.

Still another circuit employing two tubes in the phase inverter set-up is known by several names as; Floating Paraphase and Self Balancing Inverter. In this circuit, Fig. 4 the signal is applied to the grid of T_1 . This signal will be amplified and will appear across R_6 and R_7 which serve as the grid resistor of T_3 . At the junction of these two resistors, there will be a voltage which is of the same phase as the voltage on the grid of T_3 and is proportional to this voltage. R_7 serves as the grid resistor for T_2 . The voltage across this resistor will be a fraction of the voltage on the grid of T_3 . T_2 amplifies this voltage, which appears across the grid resistor of T_4 , R_8 - R_9 , and is 180 degrees out-of-phase with the voltage on T_3 .

R_7 is common to both the input and output circuits of T_2 . Since R_7 has the out-of-phase voltages from T_1 and T_2 flowing through it, the voltage drop will be equal to the algebraic sum of the two voltages appearing across it. It is this voltage difference that is impressed upon the grid of T_2 . Due to degeneration caused by the presence of R_7 in both input and output circuits of T_2 , the voltage ratio of the push-pull grids will never be equal to unity but the slight unbalance in the voltages upon the grids of push-pull output tubes may be tolerable if the difference does not exceed 10%. One particular advantage of this circuit is that the slight variations which may result from a mismatch of tubes or slight deviation of the values of the resistors will be compensated by the circuit, hence, it is called self-balancing.

The degenerative effect in T_2 will serve to reduce distortion and hum just as in the cathode loaded inverter.

The values for the resistors and condensers used in these circuits may be taken from any table of values for resistance coupled amplifiers. The correct operation of these circuits does not demand any expensive or hard-to-get equipment but may be adjusted with the minimum of equipment that is usually found on the work bench of any serviceman or even the moderately equipped home experimenter.

OPPORTUNITY AD-LETS

Advertisements in this section cost 20 cents a word for each insertion. Name, address and initials must be included at the above rate. Cash should accompany all classified advertisements unless placed by an accredited advertising agency. No advertisement for less than ten words accepted. Ten percent discount six issues, twenty percent for twelve issues. Objectionable or misleading advertisements not accepted. Advertisements for April, 1945, issue must reach us not later than February 23, 1945.

Radio-Craft • 25 W. B'way • New York 7, N. Y.

USED 1619 TUBES, A 6L6 WITH 2.5V FILAMENT. List \$4.50. Perfect substitute for 47, 2A5 and 59. Top for \$6.50 postpaid. Cash with order. In U.S. only. City Radio Company, 504-G E. Washington, Phoenix, Arizona.

FELLOW RADIO REPAIRMEN—REPAIR YOUR OWN tube heaters for a fraction of a cent each. Most needed parts in your junk box. Sketch (parts named) and very necessary instruction sent on receipt of one dollar. Satisfaction or refund. Hudgins Radio Service, Box 498, Beaville, Texas.

WANTED ECHOPHONE EC-1 CASH. CHARLES SCRUTON, Box 542, Hillboro, N. H.

UNIVERSAL MIDGET TOOLS: DANDY SIXTEEN Piece Set; Midget Pliers, Diagonal Cutters, Four Midget end Wrenches, Needle-nose Pliers, Screwdriver, Six Punches and Chisel, Round File Midget Crescent Wrench, \$14.85. Immediate Delivery. Remit Today. Catalogue Free With Order. DEALERS TOOL SUPPLY, 1527 Grand Ave. R.C. Kansas City, Missouri.

MAGAZINES (BACK DATED)—FOREIGN, DOMESTIC, arts, Books, booklets, subscriptions, pin-ups, etc. Catalog 10c (refund). Cicerone's, 863 First Ave., New York 17, N. Y.

BUILD A RADIO, COMPLETE KIT WITH TUBES, \$10.95. Details, Radio, 9418b Avenue "A", Brooklyn, N. Y.

PREPARE NOW FOR TREMENDOUS OPPORTUNITIES in new fields of radio after the war. Training for Federal licenses. Write for particulars, American Radio Institute, 44 East 23rd Street, New York 10, N. Y.

SCIENCE ENTHUSIASTS IN ALL FIELDS NOW HAVE a printed monthly written BY them FOR them, 15c brings latest issue, Amateur Scientists' Magazine, 45D North Evergreen, Memphis, Tenn.

SELENIUM RECTIFIERS, HALF WAVE 4 1/2 AM-peres, 10 volts \$4.50; full wave 1/3 ampere, 10 volts, \$1.85; 30 volts, 1 ampere, \$3.40. A.B. Eliminator schematic 25c, free with order, Milton Burama, 105 Avondale, Jackson, Mich.

CORRESPONDENCE COURSES AND SELF-INSTRUCTION books, slightly used. Sold, Rented, Exchanged. All subjects. Satisfaction guaranteed. Cash paid for used courses. Complete information and 92-page illustrated bargain catalog free. Write—NELSON COMPANY, Dept. 2-39, Chicago 4.

RADIO TESTING EQUIPMENT, PARTS, METERS. Will pay any reasonable price if in good condition. John Lubinski, 3340 Fulton, Cleveland 8, Ohio.

USED CORRESPONDENCE COURSES AND TECHNICAL Books Bought, Sold, Rented. Catalog Free. Educational Exchange, Henager, Alabama.

IMMEDIATE DELIVERY

RADIO PARTS

5" P.M. Speaker	\$1.39
3 1/2" P.M. Speaker Heavy Slug	1.49
4" P.M. Speaker Heavy Slug	1.69
5" P.M. Speaker Heavy Slug	1.79
6" P.M. Speaker Heavy Slug	2.55

Single conductor shielded rubber-covered microphone cable—short lengths—6 to 40'.....8c per ft.

Two conductor shielded rubber-covered microphone cable—short lengths—6 to 40'.....10c per ft.

Many other types of wire—up to 12 conductor in stock.

Write for latest bulletin listing hundreds of items available for immediate shipment.

LIFETIME SOUND

EQUIPMENT CO.

P.O. BOX 834 TOLEDO 1 OHIO, U.S.A.

METER ADAPTION

(Continued from page 344)

It is possible to multiply the voltage range of the Chanalyst to read 5,000 volts with the circuit in Fig. 6. The resistors should be mounted on a terminal board and well insulated from the case in which they are housed. The test leads should be the high-voltage type and the terminals to which they connect the standoff insulator type.

To calibrate, connect the Chanalyst to a voltage between 300 and 500 volts. Note the meter reading then connect the adaptor. Adjust R3 until the Chanalyst reads the same value as before. The range will be a 5,000 volt scale or 10 times the 500 volt scale. Once R3 is set it should require no further adjustment.

The Superior Channel Analyzer has a vacuum tube voltmeter very similar to that in the Chanalyst and the circuits described above will work satisfactorily with this instrument. Other types of ohmmeters and multimeters than those described can be modified if their characteristics are taken into consideration. Extreme care must be taken that large enough resistors are used to prevent damage to meters with the voltages applied.

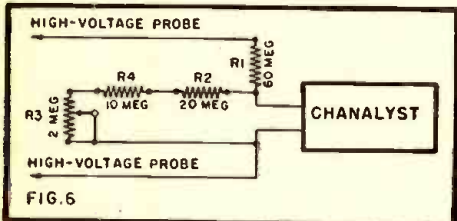

Corrosive acids from electric batteries cannot spill out and cause battery failure or damage to the plane on batteries equipped with a new valve vent. In combat flying, pilots frequently have to turn their planes upside down, causing battery acids to spill out.

The new valve vent, developed by the Auto-Lite Battery Corporation, seals the cells of the batteries in military aircraft when the plane is in any position but normal, as in a steep bank or upside-down flying. At the same time, it allows for perfect functioning by automatically opening the instant the plane returns to normal position.

Hydrogen and oxygen gases that accumulate while the battery is charging are thus allowed to exhaust without loss of vital battery acid.

"IT'S THE BEST OUT OF 20!" SAYS CHIEF ENGINEER

★ From F. S. Bailey, Chief Engineer, Radio Operator's School, Brownsville, Texas, comes this sweeping endorsement of Radio-Electronic's greatest training book: "We find Ghirardi's Radio Physics Course the best book out of 20 or more that we have tried—both as a complete course in Radio Physics, and for all other branches, including broadcasting. It is the best book for beginners as well as those who already know something about Radio. . . . It is giving our students the very best for their money!"

SEE AD ON PAGE 381 FOR DETAILS

RADIO-CRAFT for MARCH, 1945

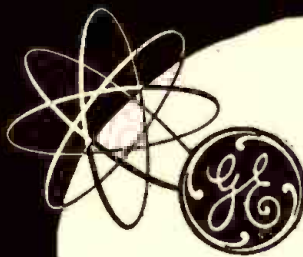

UNIMETER

This unit fulfills an extremely important need for general utility portable service equipment. It has wide range coverage for both a-c and d-c measurements of voltage, current measurements on d-c and the popular ranges on resistance.

The UM-3 is designed to clearly indicate all the functions which aid in the prevention of application of high voltages when preparing for current or resistance measurements.

Other G-E units for better servicing include: Tube Checker TC-3, Unimeter UM-4, and Oscilloscope CRO-3A.

For details write: *Electronics Department, General Electric, Schenectady 5, New York.*

Electronic Measuring Instruments



UM-3

GENERAL ELECTRIC

177-D2

HALLICRAFTERS ★ HALLICRAFTERS ★

RECEIVER HEADQUARTERS for the Nation

BEFORE the war Bob Henry served the amateurs as the world's largest distributor of communications receivers.

Now Henry Radio is Hallicrafters receiver headquarters for the Nation at war. Hallicrafters Receivers can be supplied on AA-1 priority. I can usually supply SX28As at \$223.00, SX-25s at \$94.50, and PM-23 speakers at \$15.00 at once. It takes longer to supply other models.

Soon, it is hoped, non-priority orders can be filled and Bob Henry can become again Hallicrafters headquarters for the nation at peace.

I have stores at Butler, Missouri, and at 2335 Westwood Blvd., Los Angeles 25, Calif.

Your orders and inquiries are invited.

**Bob Henry, W9ARA
HENRY RADIO SHOPS**

Butler, Mo. and Los Angeles, 25, Calif.

COMPLETE STOCKS

I have in stock some Hallicrafters receivers available for immediate delivery on priority and the following parts without priority: meter rectifiers \$1.95, transmitting tubes, transformers, resistors, condensers, panels, headsets, etc. Your orders and inquiries invited.

"WORLD'S LARGEST DISTRIBUTOR OF COMMUNICATIONS RECEIVERS"



LARGEST STOCKS CENTRALIZED SERVICE



Everything in RADIO and ELECTRONICS

REPAIR and REPLACEMENT PARTS AVAILABLE without priority

SAVE TIME CALL ALLIED FIRST!

Thousands use Allied's nation-wide service. Centralized here are today's largest and most complete stocks under one roof. Over 10,000 items from all leading manufacturers . . . for the Armed Forces, Radio Training, Laboratories, Industry and Service Replacements. Our experienced staff simplifies procurement—expedites delivery. Call ALLIED first . . . for everything!

Write, Wire, or Phone Haymarket 6800

6 Radio Books for 75c



- Dictionary of Radio Terms. No. 37-751 10c
- Radio Data Handbook. No. 37-754 25c
- Radio Circuit Handbook. No. 37-753 10c
- Radio Builders Handbook. No. 37-750 10c
- Radio Formulas & Data Book. No. 37-752 10c
- Simplified Radio Servicing. No. 37-755 10c
- All Six Books No. 37-799 . . . 75c

Write for Quantity Prices

ALLIED RADIO CORP., Dept. 2-C-5
833 W. Jackson Blvd., Chicago, Ill.

Please send following books (.....c enclosed)
 FREE 37-750 37-752 37-754
 Buying Guide 37-751 37-753 37-755
 No. 37-799 (All Six Books)

Name.....
 Address.....
 City..... State.....

ALLIED RADIO

HI-FIDELITY

(Continued from page 347)

cheap enough to allow of inclusion in even the most costly commercial receivers. What is the gain, one may reasonably ask, of cutting off at around 9,000 cycles, losing everything in between up to possibly 13,000 cycles, and then reproducing the practically insignificant added range of 13,000 through 17,000 cycles?

THE SPECTRUM IS LOGARITHMIC

Some reader may rise to say that 4,000 cycles at the extreme top end of the audio spectrum is as valuable as the same number of cycles at the low-frequency end. The argument is as unsound as it is obvious—possibly even more unsound than obvious. The first aspect of the facts is that this range might be worth as much as the 40 cycles lying between 130 and 170 cycles, or as much as the 400 cycles lying between 1300 and 1700 cycles—to compare only upon the direct basis of the significance given to each range upon the logarithmic scale that frequency-response curves are invariably plotted upon. Such plotting is employed as a means of indicating and evaluating the true importance of different segments of the total audio frequency range one to another. (See Fig. 1.)

The second reason for the insignificance of extreme high frequencies at the top of the audible spectrum is that no human voice or musical instrument generates any fundamental tone in this top range—and what little energy does appear is infrequent in appearance and so low in power in relation to that found on frequencies below about 8,000 cycles as to deserve almost no consideration in any case. The fundamental musical tone range is usually considered as lying between about 30 and 4096 cycles. True it is that harmonics, or overtones, are what give individual instruments playing the same note their individual character—but it does not take the fourth harmonic of the highest conventional musical tone to define individuality—particularly when the energy content thereof is so low as usually to be completely swamped out in the tremendously greater energy of the lower tones. Again, how often are the very high tones heard in music? Infrequently indeed, since most of the energy content lies below 1,000 cycles.

The third reason for the lack of real value of frequencies much above 8,000 cycles (so the writer believes) is the inability of most people to hear such high frequencies. They are literally inaudible to all but the very young, and to persons of freak hearing characteristics. Summarizing, the comparative insignificance of frequencies above about 8,000 cycles in conveying intelligence and emotion; the mi-

nuteness of the energy involved in them in contrast to that simultaneously present in the predominantly powerful lower frequencies; the inability of a probably sizable majority of listeners to even hear them as isolated tones (practically never found in music); the practical impossibility of their economical reproduction; and the increase in noise and distortion attendant upon any attempt to even partially reproduce them, all have convinced the writer that 8,000 cycles is an adequate upper limit to be established for "high fidelity" musical reproduction.

Before amplifying this thought, it seems well to refer each and every serious reader to the paper prepared by Leopold Stokowski and the equally vital comments thereupon by C. W. Horn, Director of Research and Development of the National Broadcasting Company, both to be found in the January, 1935, issue of the *Atlantic Monthly*. Likewise to be insisted upon as "must" reading is the recent paper by O. B. Hanson, also of N.B.C., entitled "Down to Earth on 'High Fidelity'."* These three papers are of inestimable importance to an understanding of the problem, while the divergence of opinion apparent in the attitudes of the three investigators is refreshing and decidedly productive of individual thought on the part of the reader.

DYNAMIC VOLUME RANGE

Not alone is frequency range important to fine reproduction. It is the important fundamental, but as Mr. Hanson so aptly points out, other items loom up almost equally important. Without repetition of the points he so effectively makes, emphasis may be laid upon one feature inherent in FM, as contrasted to AM, broadcasting which seems to have been woefully neglected. It has struck the writer that the claims anent extended high frequency range made for reproduction of music via FM amount to little of practical value indeed—yet emphasis heretofore has been placed upon them to the almost complete neglect of a vital improvement possible through FM. This much needed improvement is in the matter of dynamic volume range (see papers referred to). Practical requirements of AM broadcasting limit soft-to-loud volume range to about 50 db.—in contrast to the roughly 80 db. dynamic volume range required by much symphonic music to tell its emotional story.

The writer will never forget his first introduction to the possibilities inherent in volume expansion at an I.R.E. Convention held in Detroit in 1935. Several hundred normally quite unenthusiastic and profes-

*Radio, Oct., 1944.



"Making the most of a fishpole antenna."

Suggested by: Wilbur Wright, Trenton 9, N. J.

tionally "hard-boiled" radio engineers listened politely as the lecturer demonstrated a symphonic recording played through a good audio system. The demonstration repeated, but with volume expansion included, and the same audience was upon its feet, upon its chairs, literally stampeding with enthusiasm. Such, on a not particularly sympathetic audience arriving with universal "I'm from Missouri" attitude, was the effect of giving to electrical sound reproduction the full dynamic volume range written into the music by its composer—a range none had seemingly ever heard in radio reproduction before.

Would that the sales departments represented by these same engineers could have been present! Had they seen that spontaneous enthusiasm of those professionally difficult to thrill, broadcast reception might have been immeasurably improved over what it is today. Such performance comes relatively easily to FM—may the proponents thereof shift their emphasis from practically inaudible high frequencies and wake up to "sell" their so far neglected greatest asset—in the humble opinion of this writer.

HIGH VS. LOW FREQUENCIES

It is to be recognized that an 8,000-cycle top limit includes the second, generally considered predominant, harmonic or overtone of substantially the highest musical instrument fundamental tone. It includes the fourth harmonic of every tone above 2,000 cycles—and most of music lies here and below—certainly below 2666 cycles, the highest fundamental of which the third harmonic will fall within the 8,000 cycle range. (See Fig. 2.)

What of the low frequency limit? Mr. Hanson propounds the worthwhile theorem that the product, in a balanced reproducing system, of low- and high-frequency limits should be about 500,000. This would suggest that a balanced system should cover from about 63 to 8,000 cycles. Issue is taken with this thought upon the basis that the well-known public preference for bass emphasis, together with the fact that broadcasting and recordings go down to about 50 cycles, no serious violation of Mr. Hanson's precept would result from a product-figure of 400,000—the result of a range of 50 through 8,000 cycles. Even a little compromise could be effected by extending the 8,000-cycle upper limit up to possibly 9,000 cycles. There it should stop, if adjacent channel carrier whistles are to be avoided by means of the low-cost "whistle-filters" which seem to be all that even the most costly broadcast receivers can provide.

But the writer is not satisfied with even this solution. Recent work has resulted in his being able to produce quite economically, amplifiers flat (to a few db. drop at 1,000 cycles actually desirable for reasons which will appear) from 20 through 25,000 cycles. This extreme upper limit is valueless, as expected, but the ability to go down to 20 cycles has appeared to contribute wonders to reproduced music, even coming from poorly baffled, low-cost commercial 12-inch speakers such as are found in the better receivers.

Because of the variation in sensitivity vs. frequency of the human ear with differing volume levels, good reproduction mandatorily demands the ability to accentuate bass and treble frequencies by substantially 20 db., preferably a bit more, if music reproduced at moderate volume in the home is to sound at all like the same music heard at high volume in a concert hall. Such compensation may be automatic, diminishing middle register tone amplitude as the volume control is manipulated. Though an old

(Continued on following page)

RADIO-CRAFT for MARCH, 1945

Here it is!

LET GHIRARDI HELP YOU!

The BEST RADIO-ELECTRONIC TRAINING FOR BEGINNERS

Only \$5

Complete (\$5.50 foreign)

Designed throughout to help you learn at home in spare time—Easier—Better—Faster. Easily worth ten times this amount if broken into sections and sold as a "course."

at a cost you can afford!

Only \$5

Complete (\$5.50 foreign)

Designed throughout to help you learn at home in spare time—Easier—Better—Faster. Easily worth ten times this amount if broken into sections and sold as a "course."

EXAMINE IT FOR 5 DAYS—
You be the judge!

Order today. If, within 5 days after getting Ghirardi's RADIO PHYSICS COURSE book you're not fully convinced it will teach you Radio-Electronic fundamentals, **EASIER, FASTER, and at LESS COST** than any other book or course, your money will be refunded promptly and without question! This is the famous book you've been reading about in the series of little advertise-

ments on Pages 361, 367, 368, 372, 373, and 379 of this magazine. It's the famous basic Ghirardi Radio-Electronic Home study training course that you get complete for **ONLY \$5**—on a money-back guaranteed basis. It's the same big book that is used by more U. S. Army Signal Corps, Navy, and Civilian Schools and Colleges and for more home study than any other book ever published on the subject.

NO OTHER BOOK LIKE IT!

There's no other book like A. Ghirardi's RADIO PHYSICS COURSE at any price. It is larger, better illustrated, more complete, more thorough, easier to understand! No previous radio-electronic knowledge is assumed; it starts right at the beginning of the sub-

ject, with over 300 of its 972 pages devoted to a complete explanation of Electrical fundamentals alone! Actually, Ghirardi's RADIO PHYSICS COURSE gives you the scope of 36 different courses in one—packed into a big, easy-to-follow 972-page book with 508 clear illustrations and 856 self-testing review questions to help check your progress every step of the way. What other books and courses skim over, Ghirardi's RADIO PHYSICS COURSE explains fully so you understand easily and quickly. You progress as fast as you want to—and you'll find studying from it by yourself amazingly easy, even if you don't know a single thing about Radio-Electronics in the beginning. It's just what you need to get started **RIGHT** for a profitable career in this fascinating, rapidly-growing field. Send the coupon today.

REPAIR ANY RADIO-RECEIVER! PREPARE FOR A BETTER JOB IN RADIO-ELECTRONICS!



How to Test a Radio in 2 Minutes

If you repair Radios for a living—or even if you only tinker with them occasionally—Ghirardi's big 746-page 3rd edition **RADIO TROUBLESHOOTER'S HANDBOOK** is the shop book for you! Simply look up the Trouble Case History data on the set you want to repair. Nine times out of ten, the Handbook will tell you just what is wrong and just how to fix it in a jiffy! Now contains 404 pages of Case Histories for over 4,000 receiver models. Also there are 340 **ADDITIONAL PAGES** on V-F alignment peaks for over 2,000 superhets, parts substitution data, tube replacement charts, etc.—In short, a complete guide to quickly diagnosing, locating, and repairing trouble in every type of Radio in use today. Only \$5 complete (in U.S.A.). **5-DAY MONEY-BACK GUARANTEE.**



GHIRARDI'S COMPLETE COURSE IN MODERN RADIO SERVICING

Ghirardi's **MODERN RADIO SERVICING** is a big 1300-page illustrated course worth its weight in gold to anyone desiring to learn radio repair work. It's the only simple, inexpensive home-study course giving a thorough explanation of the workings of Test Instruments; Receiver Troubleshooting Procedure; Circuit Analysis; Testing & Repair of Components; Installation; Adjustment; etc. Tells how to build many types of essential instruments for your own use. 706 illust. 766 different topics. Only \$5 complete (in U.S.A.). See special Money-Saving combination offer in coupon.

Technical Division of Murray Hill Books, Inc. Dept. RC35, 232 Madison Ave., New York 16, N. Y.

- Enclosed find \$_____ for books checked (send postpaid); or Cash C. O. P. (in U.S.A. only) for this amount plus postage. If not fully satisfied, I may return the books within 5 days and receive my money back.
- RADIO PHYSICS COURSE** \$5 (\$5.50 foreign)
- SPECIAL MONEY-SAVING COMBINATION** (two books) Modern Radio Servicing and Radio Troubleshooter's Handbook \$9.50 (\$10.50 foreign) for the two!
- 3rd Edit. **RADIO TROUBLE-SHOOTER'S HANDBOOK** \$5 (\$5.50 foreign)
- MODERN RADIO SERVICING** \$5 (\$5.50 foreign)

Name _____

Address _____

City & Dist. No. _____ State _____

GET STARTED NOW! MAIL COUPON TODAY!

Learn RADIO-ELECTRONICS-TELEVISION



12 WEEKS TRAINING IN COYNE SHOPS WHERE YOU "LEARN-BY-DOING"

Trained Radio-Electronics men needed now. They will be needed too when the war is over. Tremendous expansion in Radio, Electronics, Frequency Modulation and Television predicted—a world of new opportunities. Get Radio Training in the Coyne Shops in Chicago now, and BE READY!

Will Finance Your Training

If you are short of money, you can start now and pay most of your tuition after you graduate. Many earn while learning. Free Lifetime Employment Service to graduates. EXTRA training in INDUSTRIAL ELECTRONICS—no extra cost.

Men with Physical Disabilities—we have special facilities for you. If you have a physical disability of any kind write me when you send coupon.

FREE BOOK! Whether you're 16 or up to 40, get about your future in Radio-Electronics-Television. Mail coupon today.

H. C. LEWIS, Pres., RADIO-ELECTRONICS DIVISION
COYNE ELECTRICAL SCHOOL
500 S. Paulina St., Dept. 35-84 Chicago 12, Illinois
Send me FREE BOOK on COYNE RADIO-ELECTRONICS-TELEVISION TRAINING, extra Industrial Electronics course, and details of "Pay-After-Graduation" Plan.

NAME.....
ADDRESS.....
CITY..... ZONE..... STATE.....

LAKE Radio Cabinets & Parts



Portable Phonograph case, of sturdy durable plywood, in handsome brown leatherette finish. Inside dimensions 16 1/2" long, 14" wide, 9 1/2" high. Has blank motor board. As illustrated above, specially priced at **\$6.95**

Also blank table cabinets of walnut veneer in the following sizes, with speaker opening on left front side. (Note: 7" has center speaker grill.)

#1	8"	L x 8 1/2"	H x 4"	D	\$1.95
#2	10"	L x 6 1/2"	H x 5"	D	\$2.75
#3	13 1/2"	L x 7 1/2"	H x 6 1/2"	D	\$3.25
#4	16"	L x 7 1/2"	H x 8 1/2"	D	\$2.50
#5	17"	L x 9"	H x 9 1/2"	D	\$4.50
#6	21"	L x 9 1/2"	H x 10 1/2"	D	\$5.50

*Speaker Opening in center of front side. Cabinets available in ivory color and Swedish Modern. Write for prices.

POWER TRANSFORMERS

4, 5, or 6 Tube—6.3V at 2 amp. 50 Mill Power Transformer	\$2.45
7, 8, or 9 Tube—6.3V at 3 amp. 70 Mill Power Transformer	\$2.65

All types of radio parts available in today's market can be obtained at Lake's money-saving prices.

Write For Our Free, New Illustrated Catalog!
LAKE RADIO SALES CO.
615 W. Randolph Street Chicago 6, Ill.

BUILD YOUR OWN!

*FAST-FREEZER



Every amateur will be proud to build this modern household necessity. It just takes a few hours of your spare time to build, and operates electrically on any voltage. There's fun in building and profit in using this handy freezer. Saves up to 75%.

NO EXPERT KNOWLEDGE NEEDED

Our plans are simple and easy to follow and this 8 or 12 cubic foot size can be built of new or used parts. Mail \$1 bill, check or money order for complete plans and catalog.

LEJAY MFG., 456 LeJay Bldg., Minneapolis 8, Minn.

BUY WAR BONDS

HI-FIDELITY

(Continued from previous page)

method, the writer recalls no commercial example which does this to the necessary degree—the best providing only a partial step in the right direction—a disappointing compromise at best. It is strongly felt that by providing such essential compensation in the form of separate bass and treble frequency controls the basic requirement is satisfied, and satisfied exactly as the user may prefer, and as the invariably different and differing acoustics of his particular living room may require.

No impossible project requiring extensive investigation and research is needed to satisfy the desiderata set forth above. At a final selling cost of probably no more than five dollars higher than any good receiver commands today, the need for better than 20 db. of controllable bass and treble frequency accentuation with but one more knob than usual, together with a frequency range flat from 20 cycles up to beyond the top limit of audibility, can be fully satisfied.

DISTORTION ALSO A FACTOR

The question of distortion is also important, and in it lies an opportunity of improvement in actual musical reproduction today believed to be little recognized. Theoretically no harmonic (amplitude) distortion may be tolerated in an ideally perfect reproducing system. In conventional amplifiers phase distortion is usually of insignificant degree and overall effect, so may be neglected. The human ear appears to be not particularly sensitive to even-harmonic distortion, even when present in considerable degree. The ear is noticeably more sensitive to odd-harmonic distortion, and it is this which effort should be expended to minimize. Such is theory. Extended tests upon a reproducing system exhibiting less than 1% total harmonic distortion and involving hundreds of listeners indicated quite positively that reproduction was dull, lifeless and generally displeasing. The introduction of discreet orders of odd harmonic distortion at once restored the life and brilliance completely lacking in the "distortionless" system. It is felt that this thought is worthy of more serious consideration and quantitative investigation.

If the inescapable conclusions resulting from many tests and investigations conducted by such organizations as the Bell Telephone Laboratories establishing 8,000 cycles to be a top frequency limit adequate to satisfy a predominant majority of all listeners be recognized, then is not a boon—rather than a degradation—conferred upon FM broadcasting by expanding the service it can render through cutting present 200 Kc. channels to 100 Kc.? The writer, basing his decision upon over three decades in radio, with much of this time concentrated upon the design of equipment calculated to provide the then ultimate in tonal reproduction, so believes. He regards 15,000 cycle FM audio range requiring 5:1 deviation ratio—which yields a swing of 150 Kc., and thus necessitate a 200 Kc. total band width to provide a 12 1/2% "guard-band" on each side as possibly unjustified. It is respectfully suggested that two stations where but one grew before, each of quality adequate to fully satisfy probably 99% of all listeners, is more desirable than the questionably idealistic seeking of an ultimate appreciated by but a small minority of the radio audience—at the cost of a possible limitation of useful service.

FOR SALE HARD-TO-GET ITEMS

All items are brand new, except where indicated. ALL are in PERFECT WORKING ORDER. In many cases, the parts alone total more than the price we are asking. Satisfaction guaranteed or your money back. ORDER FROM THIS PAGE. Use our convenient coupon. Include sufficient extra remittance for parcel post charges, otherwise order is sent express collect. Any excess will be refunded. All C.O.D. shipments require 20% deposit. No C.O.D. shipments on orders for less than \$5.00. If full remittance accompanies order deduct 2% discount. Send money order, certified check, or new U. S. stamps. No C. O. D.'s to foreign countries.

ULTRA MAGNET

LIFTS MORE THAN 20 TIMES ITS OWN WEIGHT

LITTLE GIANT MAGNET
Lifts 5 lbs. easily. Weighs 4 oz. Made of ALNICO new high-magnetic steel. Complete with keeper. World's most powerful magnet ever made. The experimenter and hobbyist will find hundreds of excellent uses for this high quality permanent magnet. Measures 1 3/4" x 1 1/2" Shp. Wt. 3.5 lbs.
ITEM NO. 159
YOUR PRICE **\$1.50**



GENUINE MICROPHONE TRANSMITTERS

These are regular "telephone transmitters" of the type used on wall telephones. Taken from a large telephone supply company's overstock, these are miles ahead of the opportunity to obtain a splendid unit for little more than the price usually asked for a simple "microphone button". The amateur experimenter and telephone mechanic will find a variety of uses for these excellent microphones. They work perfectly on 2 dry cells.

Can be used on P.A. systems for voice transmissions, in call systems and intercommunications sets. With telephone receivers (radio headphones will do) they may be made into short-line telephone circuits, such as house-to-house or farm-to-farm "phone lines." You can use them to talk through your own radio or as concealed dictaphone pick-up units for listening to conversations in a distant room or building. The telephone mechanic will find these useful replacements on battery-operated rural telephone lines.

THESE ARE GENUINE TRANSMITTERS. MADE BY KELLOGG, WESTERN ELECTRIC AND STROMBERG-CARLSON. Excellent in appearance and operation. A remarkable value, and one seldom offered in these times. Shp. Wt. 1 lb.
ITEM NO. 160
YOUR PRICE **\$1.50**

AMAZING BLACK LIGHT!

Powerful 250-Watt Ultra-Violet Source
The best and most practical source of ultra-violet light for general experimental and entertainment use. Makes all fluorescent substances brilliantly luminescent. No transformers of any kind needed. Fits any standard lamp socket. Made with special filter glass permitting only ultra-violet rays to come through. Brings out beautiful opalescent hues in various types of materials. Swell for amateur parties, plays, etc., to obtain unique lighting effects. Bulb only. Shp. Wt. 2 lbs.
ITEM NO. 87
YOUR PRICE **\$2.45**

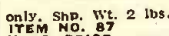

WATT HOUR METER

Completely overhauled and ready for immediate service. Designed for regular 110-volt, 60 cycle 2-wire A.C. circuit. Servicemen use it in their shops to check current consumption of sets, soldering irons, etc. Keeps costs down. If dismantled, the parts alone would bring the price. The elaborate gear train could be used as a counter on machines of various kinds. Simple to install: 2 wires from the line and 2 wires to the load. Sturdily constructed in heavy metal case. 4 1/2" high, 6 1/2" wide, 5" deep. Westinghouse, G. E., Ft. Wayne, Sangamo or other available make. Shp. Wt. 4 lbs.
ITEM NO. 33
YOUR PRICE **\$5.95**



LIMITED QUANTITIES! PROMPT SHIPMENTS!

It's Easy to Order—Clip Coupon—Order from This Page—No Catalog Sent.
MAIL TODAY—NOW!
(See Corresponding Ad Page 387)

HUDSON SPECIALTIES CO.

40 West Broadway, Dept. RC-3-45, New York 7, N. Y.
I have circled below the numbers of the items I'm ordering. My full remittance of \$..... (NO C.O.D. ORDERS UNLESS ACCOMPANIED WITH A DEPOSIT.) OR my deposit of \$..... is enclosed (20% required) ship order C.O.D. for balance. NO C.O.D. ORDER FOR LESS THAN \$5.00 (New U. S. stamps, check or money order accepted.)
Circle Item No. wanted: 33 87 159 160

Name.....
Address..... Please Print Clearly
City..... State.....
Send remittance by check, stamps or money order; register letter if you send cash or stamps.

TECHNOTES

... I.F. TRANSFORMERS

An unusual difficulty was found in a Tru-tone D3115—3-way. Reception was normal only on locals.

I found that the I.F. transformer near the ballast tube had become so hot that the wax had melted, causing the coils to slide apart. It was necessary to respace the coils and cement them in position, then align the set.

J. F. MACK,
Greenville, S. C.

... WAR-TIME SERVICE

The following idea saves time and makes possible changing back to the original tubes without rewiring.

I replace a 5Z3 or 80 with a 5U4G (where the transformer takes the added load) as follows: Cut off pin No. 1 with cutters and saw off the center pin. Now build up pins 2 and 8 with solder so that they are as big as the filament pins on 4-prong tubes.

The idea may be applied to the 39/44 which may be used in place of the 6D6. Melt solder from pin No. 3 of the former tube, without breaking the wire inside, and extend the lead with a piece of hookup wire. Now build up the heater prongs with solder, and feed the 39/44 screen lead into the screen socket hole, connecting it with the lug underneath. The 39/44 suppressor is connected internally so no connection is necessary.

E. E. YOUNGKIN,
Altoona, Pa.

... TRAVELLER T-K-510

This set stopped intermittently when subject to vibration, such as when anyone walked by the radio or attempted to play records. The obvious short was hard to track down, but was finally traced to a resistor mounted just under the phono switch. It was so close to chassis and switch that a slight jar caused a short.

HAROLD WURM,
Appleton, Wisc.

... ZENITH RADIOS WITH 1L TUBES

Some service men have found that some Zenith radios having the 1L series of tubes play at the high end of the dial but not at the low end. This can in most cases be cured by replacing the 33,000-ohm screen grid resistor with one of a higher value of about 100,000 to 200,000 ohms.

DAVID HOWARD, JR.,
Sanford, Florida.

... 1A7-GT REPLACEMENT

This scarce tube may be replaced by a 1R5 miniature tube by making an adapter with a 1R5 socket and octal tube base. The adapter is wired as follows:

1R5 socket		octal socket
No. 1	to	No. 7
2		3
3		6
4		5
5		no connection
6		8
7		2

Use spaghetti tubing wherever the leads criss-cross inside the base. Wires should be pulled tight, soldered and clipped off.

The No. 8 terminal of the 1A7GT socket is connected to the bottom lug terminal of the mixer section stator plates, the lead being shielded. A hole may be drilled in the chassis for this lead if one is not already present.

Also disconnect that end of the plate winding of the oscillator coil from B plus and solder it to No. 4 of the 1A7GT to provide proper oscillator plate voltage.

GEORGE MURAKAMI,
Newell, Calif.

... GRID LEAD EXTENSION

In substituting a glass tube for a metal one, it is frequently found that the grid lead must be extended. Instead of taking the chassis out, this simple procedure may be followed:

Make an adapter wire by attaching a glass grid clip on one end and a cap from an old metal tube at the other. It is then possible to instantly change from one type tube to the other.

TOIVO E. PEKONEN,
Marinette, Wis.

... 12SA7 SUBSTITUTION

Due to 12SA7 shortage, I am passing along an idea which uses a 7A8-G as replacement. I find that the center prong of the latter fits snugly into the center prong of the 12SA7 so I use the latter base as a socket, in accordance with diagram.

Lead wires from one base to the other are shown, with sleeves made up from 12SA7 base prongs slipped over the local pins. Use a 60-ohm, 1-watt resistor in series with the 7A8-G, since it is a 6-volt tube.

G. S. COBBOLD,
Sarnia, Ont.

(Continued on page opposite 390)

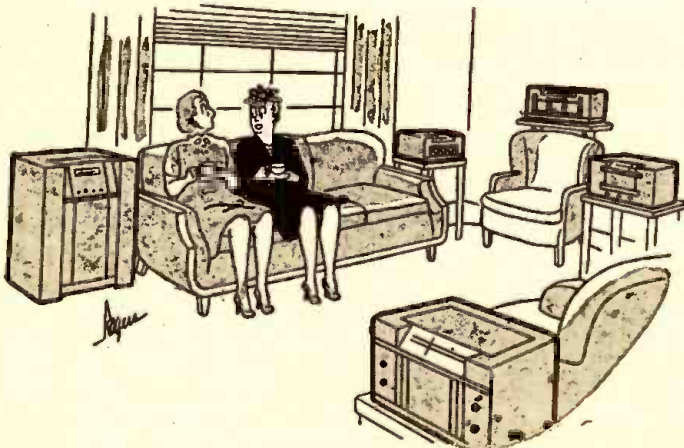

"By the way my dear, have you seen that handsome new salesman at the radio store yet?"

RADIO-CRAFT for MARCH, 1945

New Direct-Coupled FM - AM AMPLIFIER MANUAL

By A. C. SHANEY

Chief Engineer, Amplifier Co. of America

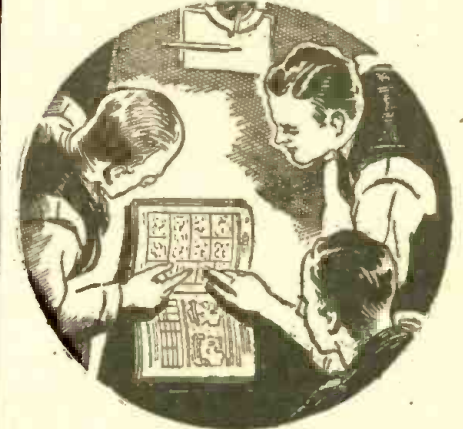

For the Layman, Serviceman
Recordist and Engineer

Regardless of whether you are interested in the finest type of phonograph reproduction, high fidelity recording, sound-on-film applications, FM or AM programs, you will find invaluable information in this practical handbook. Written by the leading exponent of direct-coupled amplifiers who has spent more than 10 years improving and perfecting the famous Loftin-White circuit.

Explains the theory and practical
application of:

Variable Speed Non-Overloading Push-Pull Expansion
Non-Frequency Discriminating Scratch Suppression
Push-Pull Balanced Direct-Coupled Amplification
Push-Pull High-Frequency Equalization
Push-Pull Low-Frequency Equalization
Push-Pull Volume Compression
Automatic Volume Limitation
Automatic Volume Control
Calibrated V. U. Indicator
Audio Spectrum Control
Remote Control

If you are interested in the latest audio developments, you can't afford to be without this complete compilation of authentic articles on Direct-Coupled Amplifiers. 89 pages 8 1/2" x 11". Over 100 diagrams and illustrations.

Priced to Cover Cost of 25c
Printing and Mailing

Send U. S. Stamps or Coin

AMPLIFIER CO. of AMERICA

396 BROADWAY

NEW YORK, N. Y.

12 WEEKS SHOP TRAINING TRAIN FOR YOUR PLACE IN **ELECTRICITY**

All Finance Your Training

EXTRA

4 WEEKS

COURSE IN

INDUSTRIAL

ELECTRONICS

INCLUDED!

At Coyne you "Learn by Doing" on real machinery and equipment. Trained Electrical men needed now. Electricity offers you opportunities for the best jobs today, and a real peace-time future. Don't let the opportunities of peace-time catch you unprepared. Get your electrical training now.

EARN WHILE LEARNING, JOB HELP AFTER GRADUATION

The place to get your electrical training is at Coyne. We have been training men and young men for 45 years — by the famous "Learn by Doing" method in the great Chicago shops of Coyne. Many do part-time work to help out with expenses. Free lifetime employment service when you graduate.

Right now I'm including extra training in Industrial Electronics at no extra cost. Send coupon now for Free Book and details. No obligation; no salesman will call. I want to send you the facts and let you decide. Mail coupon today.

H. C. LEWIS, President
COYNE ELECTRICAL SCHOOL
500 S. Paulina St., Dept. 35-78 Chicago, Ill.
Send me your Free Book and tell me about your plans to help me.

Name

Address

City Zone ... State



We have facilities for men with physical disabilities. If you have a physical disability of any kind write me when you send the coupon.



IS *Your* OPPORTUNITY HERE?

Think this over carefully. Where do you go from the spot you're in now? Are your surroundings friendly and full of promise for the future? Consider now the place you might fill in the electronic industry leadership assured to the fine staff of engineers, scientists, technicians at NATIONAL UNION RADIO CORPORATION. We're all young in years and ideas though most of us are old in electronic experience. We enjoy working together. We know we're going places! We're inviting you to join us if you have the qualifications. If you're looking for a success pattern for your future, it may be here with us at National Union. Find out! Come in and talk it over or write us!

NATIONAL UNION WANTS:

- * **QUALITY CONTROL ENGINEER AND SENIOR TUBE ENGINEERS**
—These men **MUST** have executive ability and extensive experience with radio tube manufacture. The pay and opportunities are commensurate with your ability.
- * **COMMERCIAL ENGINEERS**—Men with pleasing personalities, initiative and a knowledge of vacuum tube applications.
- * **QUALITY CONTROL MEN**—Statistical Training is chief requirement though a knowledge of vacuum tubes will help.
- * **JUNIOR ENGINEERS—MEN or WOMEN**—If you have a college degree in Physics, Electrical Engineering, Mathematics or Chemistry and are the type of young person who is able to 'go places,' you'll be starting with your best foot forward if you are accepted at National Union Radio Corporation.
- * **FOREMEN and ASSISTANT FOREMEN**—Men with foremanship experience in exhaust, stem or grid operations in radio tube manufacture.
- * **TECHNICIANS, CIRCUIT MEN**—Maybe you've been repairing radios, maybe you've gained a knowledge of circuits by working on test equipment. It makes no difference either way if you have the 'know how' of circuits write us about the opportunities we have to offer!

WOMEN!

We have a number of fine young women engineers with us now. We need more. If you have a degree in Electrical Engineering, Physics, Chemistry or Mathematics and are seeking career opportunities, investigate.

Phone or Write

DR. L. GRANT HECTOR

Director of Engineering

NATIONAL UNION RADIO CORPORATION

RESEARCH LABORATORIES

Plane St. at Raymond Blvd.

Newark 2, New Jersey

WMC RULES OBSERVED

ELECTRICAL and RADIO ENGINEERS

RADIO TECHNICIANS

FOR DESIGN, DEVELOPMENT
AND PRODUCTION WORK
POST WAR OPPORTUNITY

ALLEN D. CARDWELL MFG. CORP.

81 Prospect St.

Brooklyn

WANTED

RADIO LICENSED AMATEURS

thoroughly familiar with all types of parts, tubes, meters, test equipment, receivers, transmitters, etc. Permanent position; excellent salary; splendid opportunity for some one residing in metropolitan New York area.

SUN RADIO & ELECTRONICS CO.

212 Fulton Street

New York 7, N. Y.

Wanted!

RADIO OPERATORS

Uncle Sam's merchant ships need qualified radio operators NOW—to help guard the men and goods shipped overseas—to help bring V Day nearer! If you're a ham, this is YOUR JOB! Praised by m s g, Radio News, and Radio-Craft, the MARINE RADIO MANUAL, edited by radio operator M. H. Strichartz, will help you get that job. It's the only book of its kind—up-to-the-minute, reliable, practical, clearly written. Order YOUR copy now! 517 Pages, \$4.00.

We pay postage if you remit with order.

CORNELL MARITIME PRESS

241 W. 23rd St. Dept. RC New York 11

RADIO ELECTRONICS MONTHLY REVIEW

(Continued from page 339)

versial questions at the allocations hearing. The proposed solution permits continued service on the lower frequencies while not hindering future development on the higher.

The success of the "walkie-talkie" on the battlefield and the possibilities for its varied uses in peacetime have induced the Commission to allocate the band from 460 to 470 mc for a new radio service to be known as the "Citizens Radiocommunication Service." Small portable radios can be used, for example, to establish a physicians' calling service, for communication to and from trucks and tractors operating in and around large plants, on farms and ranches, on board harbor and river craft, in mountain and swamp areas.

Provision is also made for a Rural Telephone Service to furnish a radio-telephone link for isolated communities, farmers, ranchers, miners and others who cannot be or are not served by wire line facilities. The Commission does not set aside specific frequencies for this service but will permit it to share the band of frequencies allocated to television, most of which will be concentrated in urban areas.

The allocation plan boosts the number of channels allotted to amateurs, pointing out that this service is one of the oldest in radio and its development closely parallels that of the entire radio art. The Amateur Service is a vast training school and constitutes a huge reservoir of skilled radio operators, experienced in handling radio communications through terrific interference and radio technicians skilled in the building, operation and maintenance of radio equipment; states the FCC report.

Its week-long hearing in September on the use of Railroad Radio having shown that it will contribute to the safety of life and property and should be of almost universal benefit to the public, the Commission has set aside a sizeable number of channels for that purpose.

Channels have been set aside for much wider use of radio by fire departments. Ninety-two cities of over 100,000 population intend to use such a service.

Three bands are assigned for industrial and medical radio equipment to prevent interference with other radio services.

Among other services expanded by the new proposed allocations are aircraft radio; police radio (including channels for the facsimile transmission of photos and fingerprints between police departments and to and from the FBI in Washington) and emergency and miscellaneous services, including maintenance departments of gas, electric and transportation companies, reporting of news events, forestry services and oil prospecting.

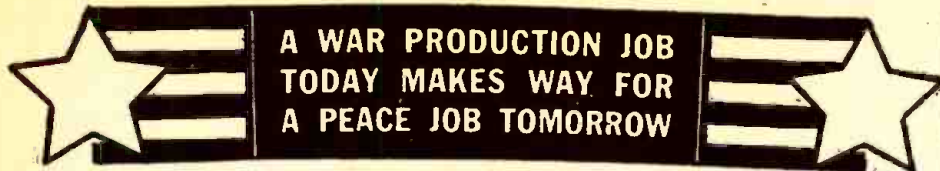

ENGINEERS

Are You Concerned With YOUR POST WAR FUTURE ?

The Federal Telephone & Radio Corporation, the manufacturing unit of the International Telephone & Telegraph Corporation with its multiple business activities extending to all parts of the civilized world, will accept applications from experienced men for immediate employment with almost limitless post war possibilities. These positions should interest those with an eye to the future and whose interest lies in forging ahead with this internationally known organization whose expansion plans for post war are of great magnitude covering all types of radio & telephone communications. Advancement as rapid as ability warrants. Majority of positions are located in the New York area!

We need the following personnel! Men with long experience or recent graduates considered.

- ENGINEERS
- ELECTRONICS
- ELECTRICAL
- RADIO
- MECHANICAL
- CHEMICAL
- TRANSFORMER DESIGN
- SALES AND APPLICATION ENGINEERS
- PHYSICISTS
- DESIGNERS
- DRAFTSMEN
- TOOL DESIGNERS
- TECHNICAL WRITERS

Look Ahead With Federal!

If inconvenient to apply in person, write letter in full, detailing about yourself, education, experience, age, etc., to Personnel Manager.

FEDERAL TELEPHONE & RADIO CORP.
39 Central Avenue
EAST NEWARK NEW JERSEY

FIELD SERVICE ENGINEERS

For Domestic and Foreign Service
Must possess good knowledge of Radio

Essential workers need release.

HAZELTINE CORPORATION

58-25 Little Neck Parkway
Little Neck, Long Island

The recently-finished allocations hearings of the FCC broke world's records for verbiage. More than 1,000,000 words were presented by 258 witnesses during its sessions. Printed record of the hearings covered 4,599 pages at about 240 words per page.

HELP WANTED

TRANSFORMER & SMALL ELECTRIC MOTOR MEN

ENGINEERS
DESIGNERS
DRAFTSMEN
TECHNICIANS

For war time and post-war design and development of intricate, specialized, hermetically sealed transformers, and special purpose fractional h.p. motors.

Write, giving details about age, experience, past salaries to

SPERRY

GYROSCOPE COMPANY, INC.
RESEARCH LABORATORIES
STEWART AVE. AND CLINTON RD.
GARDEN CITY, NEW YORK

Wanted ENGINEERS

Radio

*Electrical

Electronic

*Mechanical

Metallurgical

*Factory Planning

Materials Handling

Manufacturing Planning

Work in connection with the manufacture of a wide variety of new and advanced types of communications equipment and special electronic products.

Apply (or write), giving full qualifications, to:

R.L.D., EMPLOYMENT DEPT.

Western Electric Co.

100 CENTRAL AV., KEARNY, N. J.

*Also: C.A.L.

Locust St., Haverhill, Mass.

Applicants must comply with WMC regulations

RADIO RESEARCH Development (Post-War Opportunity)

Expanding national organization has 3 openings on its Research-Development Field Staff. These positions entail some travel with full expenses and allowances paid by the company. Knowledge of radio set construction or definite mechanical ability essential. The positions are permanent and offer an exceptionally fine post-war future. Starting salary-\$172.50-\$200.00 per month depending upon ability. Periodic increases based on merit. If you are interested in joining an expanding and progressive company, please give us in confidence full details about yourself for a personal interview.

BOX 315, RADIO-CRAFT
25 West Broadway
New York 7, N. Y.

NATION-WIDE
MAIL ORDER
DISTRIBUTORS
SINCE 1928



RADIO AND ELECTRONIC DEVICES

For...

TRADE... INDUSTRY...
COMMUNICATION...
PUBLIC UTILITY...
VOCATIONAL AND
EXPERIMENTAL
APPLICATIONS

BURSTEIN-APPLEBEE CO.

1012-14 MCGEE ST.
KANSAS CITY 6, MISSOURI

ELECTRICIANS! RADIO MEN!

Earn More Money!

Get this new
GIANT SIZE

**ELECTRICAL
and RADIO
TROUBLE
SHOOTING
MANUAL**

GUARANTEED BY
COYNE

Yours 10 Days Free!

Needed by was workers, maintenance men, beginners, old timers! Nothing else like it. Saves time, helps boost your pay... **4 GREAT BOOKS IN ONE!**
1. New Step-by-Step Trouble Shooting Course. 2. 500 Shop Prints. 3. Elec-Radio Dictionary. 4. Spare Time Jobs.

FREE! 1 yr. Technical Counsel by mail from COYNE staff, on trouble-shooting problems.
SEND NO MONEY! See offer below. Satisfaction guaranteed by famous COYNE "Learn-by-Doing" Electrical School. Rush coupon now!

**OVER
500**

Large Size
Electrical and Radio
Shop Prints
-How to read
and use them

H. C. LEWIS, Pres., Dept. 357-2
COYNE ELECTRICAL SCHOOL
500 S. Pauline St., Chicago 12, Ill.
Send, with all shipping charges paid, your new COYNE Electrical and Radio Trouble Shooting Manual. Within 10 days after getting it (1) either return it or send \$5, then \$3 monthly until total of \$8.90 is paid. () Cash price \$8.00—you save over 10%. Same 10-day free trial and return privilege.

**FREE TRIAL
COUPON**

NAME _____
ADDRESS _____
CITY _____ STATE _____

YOUR NEW FREE CATALOG IS READY FOR YOU!

Radionic's Catalog No. 26 lists hard-to-get radio parts!
Helps you fill your radio and electronic needs.

All parts are available for immediate shipment. All are highest quality. All are exceptional values.

SEND TODAY FOR YOUR FREE COPY TO:

Radionic Equipment Company
Dept. 3E

"Chancellor" Products
170 Nassau Street, New York 7, N. Y.

The Mail Bag

AUTOMATIC RECORD CHANGER COURSE

Dear Editor:

I am at present a subscriber to your magazine and am sending in a couple of radio circuits that I have previously built so that maybe some other fellows may like to try.

While I am at it, I would like to say that I just got through reading part 2 of "Automatic Changers" by John Needre in your December issue. It sure is a help to read something like this. That's what I like about your magazine—when a fellow subscribes to it, he can bet that before the subscription runs out he will have radio material at no cost, which if bought by publishing houses, would run up into money.

I also came across another article in your December issue. The article on "Alien Enemy Patents" on page 158. I liked the circuits, especially the "Space-Charge Receiver" No. 6. It's the one-tube phono-radio

receiver. I think its a neat little rig, don't you? Can any more information be given on this circuit—the tube and battery voltage?

GEO. R. ANGLADO,
Biloxi, Miss.

(While such a tube [high power capability combined with extremely high mutual conductance] can definitely be built as shown by the patent, no tube of this type is at present commercially available. A person might experiment, however, with a tube like the 59 or 89, using any standard grid-leak condenser combination for the radio application. A bleeder resistor with variable sliders could be used for the variable voltage supply, and the sliders adjusted for best results. Possibly two or three volts positive for the first grid and 75 for the third would be good for an initial experimental setting.—Editor)

OFFERS SOME NOTES AND SUGGESTIONS

Dear Editor:

Here are a few notes and suggestions: (1) A.C.-D.C. Intercommunicator (pg. 224, January, 1945):

As shown, speaker connects to secondary of T1 when switch S1 is in "talk" position, thus feeding line at "mic." level. I assume that the intention was to use the amplifier as a line driver. To accomplish this, leads from T1 secondary and T2 primary to S1 should be transposed at the transformers. Fifty miles from microphone to amplifier input? NO! I DON'T BELIEVE IT—not without a line driver!

(2) Electronic Symbols (pg. 215, January, 1945):

Why not start a campaign for suggestions for suitable symbols to fill in the vacant spots, as well as to replace many of the existing ones that are in the same impractical class with that "Variable Trimmer Capacitor"? Tabulations of suggested symbols and users' opinions of the present ones would certainly be of great value at a post-war standardization conference. Many present symbols are hard to draw—harder to ink in—and it will take an act of Congress to make most of our amateur draftsmen use such as that new "Variable Trimmer Capacitor" symbol!

(3) A thought on construction and calibration of Volt-Ohmmeters:

For the man who wants more than average accuracy, and is willing to increase his budget a little—reduce the size of series resistors for the various ranges by about 5%, and add a good rheostat of about 10% of the original resistor value, connecting in series. Now ordinary carbon resistors can be used and the rheostat allows adjustment for accurate calibration, as well as providing easy means of correcting for any change of resistor value after a period of use and aging. EXAMPLE: Calculated series resistor, 1000 ohms. Use 950 ohms and 100 ohm rheostat in series, or 900 ohms and 150 or 200 ohm rheostat in series.

This idea is especially good in calibrating A.C. ranges of rectifier type meters, since rectifiers vary all over the neighborhood, and a replacement rectifier is very seldom identical in characteristics with the original.

JOSEPH J. HILEY,
Tacoma, Wash.

(Radio-Craft would indeed be interested in receiving any criticisms or comments on the new symbols, especially from draftsmen. Any letters of general interest will be printed.—Editor)

WATCH THOSE BLOCKING CONDENSERS

Dear Editor:

Judging from a number of articles which have appeared in various technical publications, it would seem that there still are a large number of servicemen who erroneously believe that if a solid dielectric condenser shows no appreciable degree of leakage when tested with an ohmmeter having a maximum resistance range of 10,000 ohms, or even one megohm, it will function normally. The rashness of this assumption is particularly apparent when dealing with AVC circuits where a leakage resistance of 500,000 ohms would, in many cases, reduce the AVC voltage by 80 per cent.

The importance of accurately determining the true worth of a condenser is more than merely a point of academic interest and per-

haps will be more clearly understood by some servicemen if I cite a specific case history. The receiver, an Airline Model 1170, would receive only local stations and these at low volume. After replacing an AVC condenser with a leakage resistance of 3 MEGOHMS, the receiver performed normally.

Good paper condensers should have 100 megohms and mica condensers 200 megohms leakage resistance per micro-farad of capacity. It is interesting to note that on this basis a .25 mfd. paper by-pass condenser should have a leakage resistance of 400 megohms.

PAUL T. BAUMAN,
St. Cloud, Minn.

RADIO-CRAFT for MARCH, 1945

FOR SALE HARD-TO-GET ITEMS

All items are brand new, except where indicated. ALL are in **PERFECT WORKING ORDER**. In many cases, the parts alone total more than the price we are asking. Satisfaction guaranteed or your money back. **ORDER FROM THIS PAGE.** Use our convenient coupon. Include sufficient extra remittance for Parcel Post charges, otherwise order is sent express collect. Any excess will be refunded. All C.O.D. shipments require 20% deposit. No C.O.D. shipments on orders for less than \$5.00. If full remittance accompanies order deduct 2% discount. Send money order, certified check, or New U. S. stamps. No C. O. D.'s to foreign countries.

THE MAGIC ELECTRIC WELDER



Here is one of the most compact, practical welders we have ever seen. Anyone can use it for shop, farm and home repairs. **WELDS BRAZES, SOLDER, CUTS ALL METALS.** ANODE CARBONS OPERATE IT. Repairs steel, cast iron, aluminum, brass, copper, etc. Complete with power unit, flame and metallic carbons, fluxes, rods, mask included. Just plug it in any electric outlet. 110 volts AC or DC. For hobbyist or professional.

GET IN ON THE GREAT WELDING BOOM. This fine set quickly teaches you welding. Low cost to operate—about 5c an hour. **COMPLETE SAFETY** is assured. No fumes with this outfit. **GET COMEJ COMPLETE**—nothing else to buy. Used by the U. S. Navy, American Tel. & Telog. Co.; Eastman Kodak Co.; Bell Laboratories, etc. **BRAND NEW OUTFIT.** Guaranteed for one year. Simple instructions with each set. **ITEM NO. 258** **YOUR PRICE \$19.95**

WESTERN ELECTRIC BREAST MIKE

This is a fine light-weight air-craft carbon microphone. It weighs only 1 lb.

Mike comes with breadplate mounting and has 2-way swiveling adjustment so that it can be adjusted to any desired position. There are 2 woven straps; one goes around neck, the other around chest. Straps can be snapped on and off quickly by an ingenious arrangement.

This excellent mike can be adapted for home broadcasting or private communication systems. By dismantling breadplate, it can be used as desk mike. Comes complete with 6-foot cord and hard rubber plug. Finished in shurardized plate, non-rustable.

THIS IS A BRAND NEW MIKE. IT HAS NEVER BEEN SOLD AT SUCH A LOW PRICE BEFORE. ORIGINAL LIST PRICE \$15.00. Shipping weight, 2 lbs. **ITEM NO. 152** **YOUR PRICE \$2.55**



POWERFUL ALL-PURPOSE INDUCTION MOTOR

IDEAL FOR EXPERIMENTERS—101 USES



Sturdily constructed to precision standards, this self-starting shaded pole A.C. induction motor is powerful enough for a number of uses. Some of these are: Automatic Timing Devices, Current Interruptors, Electric Fans, Electric Chimes, Window Displays, Photocell Control Devices, Electric Vibrators, Small Grinders, Buffers and Polishers, Miniature Pumps, Mechanical Modulators, Sirens, and other applications.

Consumes about 15 watts of power and has a speed of 3,000 r.p.m. When geared down, this sturdy unit will constantly operate an 18-inch turntable loaded with 200 lbs. dead weight—**THAT'S POWER!** Dimensions 3" high by 2" wide by 1 1/4" deep; has 4 convenient mounting studs; shaft is 1/8" long by 3/32" diameter, and runs in self-aligning oil-retaining bearings. Designed for 110-20 volts, 50-60 cycles, A.C. only. Shd. Wt. 2 lbs. **ITEM NO. 17** **YOUR PRICE \$2.25**

LIMITED QUANTITIES! PROMPT SHIPMENTS!

It's Easy to order—Clip Coupon—Order from This Page—No Catalog Sent. **MAIL TODAY—NOW!**

HUDSON SPECIALTIES CO.

40 West Broadway, Dept. RC-3-45, New York 7, N. Y.

I have enclosed below the number of the items I'm ordering. My full remittance of \$..... (include shipping charges) is enclosed. (NO C.O.D. ORDERS UNLESS ACCOMPANIED WITH A DEPOSIT.)

OR my deposit of \$..... is enclosed (20% required), shipping balance. (NO C.O.D. ORDER FOR LESS THAN \$5.00. (New U. S. stamps, check or money order accepted.)

Circle Item No. wanted 147 152 158

Name

Address

City

State

Send remittance by check, stamps or money order, register letter if you send cash or stamps.

Solve Navy Problems!

THE Navy Department is seeking solutions on a number of problems which they have turned over to the National Inventors' Council, the Federal Branch, to whom civil inventions are submitted for consideration.

If you have a solution for the problems listed below, it should be noted that suggested solutions should be prepared in sketch and description form and sent to the following agency: Mr. C. F. Kettering, Chairman, National Inventors' Council, Department of Commerce, Washington, D. C., for consideration and report.

Radio-Craft presents eight problems pertaining to radio, out of a list of 25. Should you be interested in the other problems, write to the National Inventors' Council for the 25 inventive problems issued under date of January 17th. The eight problems follow: (Numbers refer to items on the original list of 25 problems.)

NAVY INVENTIVE PROBLEMS

4. Waterproof Jack:

Applications: Microphone, headphone and key jacks for telephone equipment.

Characteristics: Should prevent water or moisture vapor from penetrating equipment, even when immersed to a depth of 10 feet; should be capable of cleaning and drying without tools; should accommodate standard plugs.

10. Single Unit Range Light:

A single optical device which will indicate with a reasonable degree of sensitivity a vessel's lateral deviation from the centerline as it proceeds along a narrow channel. Such a device must be inexpensive and low in power consumption. The conventional aid to navigation for such purposes consists of two lights on the prolongation of the centerline separated some distance from each other with the rear light higher than the front. It is in the interests of economy, and also to provide against the fact that the terrain may make the installation of two lights impractical, that this device is needed. Economy involves current consumption and cost of structures. Existing two-light ranges require approximately 50 kw. per year for a candlepower of 10,000 white.

(Problem 10, while not a radio problem, was included nevertheless in our list because the Editor felt that perhaps there is a radio solution to it. The Navy might perhaps be induced to use a simple radio beacon device which could combine radio and optics or at least a radio operated optical device instead of a purely optical one. Such a radio optical device would require very little power.—EDITOR)

14. A small portable field strength meter:

About the size and weight of a walkie-talkie for rapid checking of radio field intensities in the vicinity of radio transmitting stations. The instrument must be simple to use and accurate within plus or minus 10%. Frequency range desired is 100 kc. to 20,000 kc. The range of field intensities desired is from 10 to 1,000 millivolts per meter.

15. Radio antennas:

Up to 300 feet in height that can be set up by unskilled ground crews. The efficiency of radio devices is often limited by the extreme difficulty of obtaining reasonable antennae heights quickly in the field.

(Continued on following page)

Free!

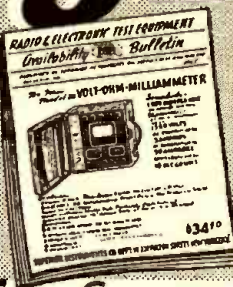

RADIO & ELECTRONIC TEST EQUIPMENT AVAILABILITY BULLETIN

Contains detailed descriptions of models we're now making.

We manufacture Volt-Ohm Milliammeters, Insulation Testers, Signal Generators and Tracers, Industrial Analyzers, Voltage Testers, etc.

SUPERIOR INSTRUMENTS CO., Dept. 151
227 Fulton St., New York 7, N. Y.

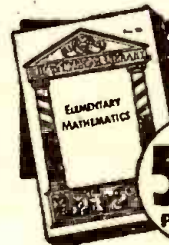

The Book that takes Drudgery out of Mathematics

Only 50¢ postpaid

Entire Chapter on Special Mathematics for the Radio Technician.

ELEMENTARY MATHEMATICS

EASY — SIMPLIFIED — PRACTICAL

Here is the book that gives you a good background in mathematics; that takes all the irritation and drudgery out of it; that you don't need to be scared of mathematics, because here's the subject explained without frills, without useless computations.

CONTENTS OF BOOK

CHAPTER I. Arithmetic—Addition—Subtraction—Multiplication—Division.
CHAPTER II. Factoring and Cancellation—Fractions—Decimals—Percentage—Ratio and Proportion.
CHAPTER III. The Metric System.
CHAPTER IV. How to Measure Surfaces and Capacity (Geometry).
CHAPTER V. Powers and Involutions—Roots and Evolution.
CHAPTER VI. Mathematics for the Manual and Technical Craftsman—Thermometer conversions—Graphs or Curve Plotting—Logarithms—Use of the Slide Rule.
CHAPTER VII. Special Mathematics for the Radio Technician.
CHAPTER VIII. Commercial Calculations—Interest—Discounts—Short Cut Arithmetic.
CHAPTER IX. Weights and Measures—Useful Tables.

ONLY 50¢ POSTPAID

Send today for your copy of this indispensable book. It can be carried readily in your pocket. (Size 6 x 9 in.)

Send Stamps, Cash or Money Order to

TECHNIFAX

1917 S. STATE ST., RC-3-45, Chicago, Ill.

TECHNIFAX 1917 S. State St., Chicago, Ill.

Enclosed herewith 50 cents, for which mail to address below your ELEMENTARY MATHEMATICS.

NAME

ADDRESS

CITY

STATE

RC-3-45

MOVIES FOR TELEVISION

"Genuine entertainment-type moving picture films" planned and made especially for television broadcasting were predicted by Ralph B. Austrian, head of R.K.O.'s Television Corporation, in a recent speech to the Television Press Club of New York City.



● They were mighty tough before Pearl Harbor. And they're even tougher now, these Type "05" Aerovox oil-filled Xmitting capacitors because of their service on many fighting fronts. You'll have these capacitors available for your bigger and better post-war ham rigs or electronic assemblies, just as soon as Uncle Sam releases them for civilian use. Meanwhile, just bear Aerovox "05" Hyvols in mind.

Convenient, moderate-priced oil-filled capacitors. Reinforced round metal can. Hyvol impregnant and fill. 600 to 3000 volt D.C.W. ratings. Capacities from 1 to 4 mfd. depending on voltage.

Immersion-proof terminals with "double-rubber-bakelite" construction. Porcelain pillar insulators. Lug-and locking nuts.

Adjustable mounting ring for upright or inverted mounting.

● Ask your jobber about these "05" Aerovox Hyvols available on suitable priorities, now, but generally available after V-Day.

AEROVOX
Capacitors
INDIVIDUALLY TESTED

AEROVOX CORP., NEW BEDFORD, MASS., U. S. A.
In Canada: AEROVOX CANADA LTD., HAMILTON, ONT.
Export: 13 E. 40 ST., NEW YORK 16, N. Y. Cable: 'ARLAB'

(Continued from previous page)

Very light alloys and special rigs for rapid erection by a ground crew without climbing are desired, in addition to ability to dismantle or collapse into packages not exceeding 20 feet in length. Insulated base vertical antennas are preferable but grounded base type could be used if the device had enough other advantages in the way of ease of erection and ruggedness.

19. A method of welding light gage aluminum:

(This is of particular interest since aluminum lifeboats and life rafts are currently of riveted construction due to the lack of a satisfactory method of welding.)

(This item, although not radio, was included because it was felt that perhaps some experimenters might wish to experiment with electronic welding which might prove to be a solution for this problem.—EDITOR)

21. Small aircraft type D.C. motors:

Without commutators, slip rings, or any other moving contact arrangements, so as to eliminate service difficulties with commutators and electrical noise produced thereby.

22. A precision twin-triode vacuum tube:

With general characteristics of the current 6SN7 type having the following additional precision features:

1. After a 15-minute warm-up, the Gm of the two sides shall be equal over the normal operating range to within + 1%.
2. The tube shall be completely nonmicrophonic.
3. The above characteristics to be maintained over an ambient temperature range + 80°C. to -40°C.
4. It would be possible to produce this type by mass production methods with not more than 10% rejects.

Note—Tubes presently available in production permit excessive variation in grid-plate conductance in the separate halves of the tube.

(It is not known whether vacuum tubes have been constructed on the thermos bottle principle, i.e., with an extra glass envelope on the outside, with the vacuum between the vacuum tube and envelope. This, it is felt, might answer the requirements listed under 3.—EDITOR)

25. A small, fast-acting, double-action solenoid:

To operate on 28 volts D.C., with a stroke of about 0.5, with a 20-pound pull (or push) at condition of maximum air gap. The plunger should "seat" at each end of travel and would very probably have to be an electromagnet whose polarity would reverse at each end of travel.

Drafting of an ordinance to bring radio repair men under the licensing power of the Police Department was asked of the City Attorney by the City Council in Los Angeles.

The ordinance is strongly recommended by the Police Commission which states that police supervision will eliminate racketeering tactics within the industry. Others have recently advocated licensing servicemen to protect the public. Magistrate Blanchfield of Brooklyn, binding over a self-styled serviceman for larceny, urged that all servicemen be required to take out licenses and post bonds. A draft ordinance for licensing servicemen has also been introduced in the Baltimore City Council.

Index to advertisers

Aerovox Corp.	388
Alden Products Co.	330
Allied Radio Corporation	380
Amperite Co.	363
Amplifier Co. of America	383
Audel & Co.	Opp. Inside Back Cover
Buck Mfg. Co.	372
Burgess Battery Co.	Opp. Inside Front Cover
Burstein-Applebee Co.	386
Cannon Co., C. F.	372
Capitol Radio Eng. Institute	378
Cardwell Mfg. Corp., Allen D.	384
Cinaudagraph Speaker, Inc.	367
Concord Radio Corporation	368
Cornell Maritime Press	384
Coyne Electrical School	382, 383, 386
DeForest Training, Inc.	333, 367
Electro-Voice Corporation	361
Fada of New York	367
Federal Telephone & Telegraph	385
General Cement Mfg. Co.	369
General Electric Co.	379
Hallicrafters Co., Inc.	329
Hazeltine Electronics Corp.	385
Henry Radio	379
Hickok Elec. Inst. Co.	Opp. Page 390
Hudson Specialties	382, 387
Lake Radio Sales Co.	382
Lancaster, Allwine & Rommel	369
LeJay Mfg. Co.	382
Lifetime Sound Equipment Co.	378
Maedel Publishing House	389
Mallory & Co., Inc., P. R.	Inside Back Cover
McElroy, T. R.	369
McGraw-Hill Book Co.	389
Meissner Mfg. Co.	Back Cover
National Radio Institute	327
National Schools	335
National Union Radio Corporation	384, Opp. Page 327
Nelson Company	370
Onan & Sons, D. W.	369
Opportunity Adlets	378
Personnel Help Wanted	384, 385
RADIO SCHOOL DIRECTORY Page 390	
American Radio Institute	
Candler System	
Capitol Radio Engineering Institute	
Commercial Radio Institute	
Lincoln Engineering School	
Melville Radio School	
Radio-Television Institute	
RCA Institutes	
New York Y.M.C.A.	
Radio Electric Service	363
Radio & Technical Division	
Murray Hill Book Co.	361, 367, 368, 372, 373, 379, 381
Radio Tube Service	376
Radio Wire Television	377
Radionic Equipment Co.	372, 386
Radolek Company	371
Raytheon Mfg. Co.	Inside front cover
Rider Publisher, Inc., John F.	373
Sperry Gyroscope, Inc.	385
Sprague Products Co.	334
Sprayberry Academy of Radio	331
Sun Radio & Electronics Corp.	384
Supreme Instruments	374
Superior Instruments Co.	387
Supreme Publications	359, 371
Sylvania Electric Co.	332
Technifax	387
Triplett Elec. Instrument Co.	336
Turner Company	365
Western Electric Co.	385
Wholesale Radio Laboratories	375
X. L. Radio Labs	367

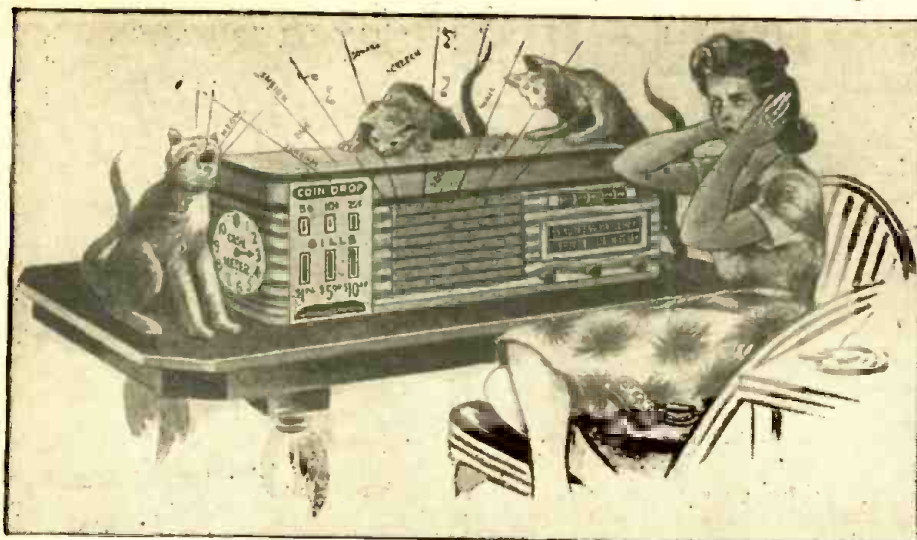

Above: Predicament of the set owner with a \$20 bill. Cats believe the set is full of mice.

A NEW KIND OF POSTWAR RADIO?

AMONG the applications made to the Federal Communications Commission at its recent hearing was one for an entirely new type of radio broadcast service. Briefly, the proposition was to inaugurate a paid broadcast service. Muzak, Inc., which now supplies music for a fee over wire lines to customers requiring such a service, was the applicant.

While the plan might have many modifications, a proposed system was one which would operate on three channels. One would be devoted to classical music, a second to lighter musical entertainment, and the third channel entirely to news reports, commentaries, announcements and talks. No advertising would appear on the programs, since the cost of supporting the system would be paid by the users.

To confine the service to those who subscribe and pay regularly, an ingenious idea was proposed. A sharp heterodyne whistle would be broadcast with the signal. This would have sufficient volume and ear-splitting sharpness to entirely destroy any entertainment value the programs might otherwise have. Special filters would be attached to subscribers' sets. These would filter out the objectionable whistles or squeals, leaving only the program with its original high-fidelity.

The objection has been urged that allotment of space to such a limited service would be a sequestration of part of the public domain to private and limited use. This is hardly valid, as with the exception of the few broadcast bands—long and short wave—practically the whole frequency spectrum is allotted to private use. There is also more than one subscription service, for news, etc., available only to those who pay for it. While no squeal technique has been evolved to prevent unauthorized listeners from using such services, issuing companies have recourse at law should unauthorized use of their service be discovered.

The tentative proposition for such an entertainment subscription service suggested that accounts would be settled by mail. Under this system, presumably a subscriber in arrears would be deprived of his filter until he paid up.

Another possible system is proposed by our artist. A coin-in-the-slot method similar to that of the "quarter gas-meter" might be adopted. The listener would simply drop in a coin and listen. (It was estimated that the proposed service would cost about five cents per day.) That this convenient system might not be without its disadvantages is plainly evident from the illustration.

TRANSFORMERS LOOK LIKE BIG TUBES



THE interesting transformers at left are made with a new rolled-core material which saves space at high frequencies.

Prewar standard laminations were 29 gauge, or about 14 mils (thousandths of an inch) thick. Then came 7-mil Hipersil, used extensively for 400-cycle aircraft transforming equipment, with an attendant saving in about 30 per cent in total weight. As rolling-mill techniques improved, the 7-mil strip was outmoded by one 5 mils thick. But for transformers in the high-frequency band and those that deliver power for but a tiny fraction of a second, 5-mil steel is much too thick. To provide an ultra-thin material an entirely new type of rolling mill was developed and built. With it, grain-oriented steel, consistent in quality and only two mils thick, has been produced. It makes possible transformers in which iron cores have not previously been possible because of the intolerably high core losses.

RADIO-CRAFT for MARCH, 1945

NOW—A REALLY HIGH-POWERED— Radio Engineering Library

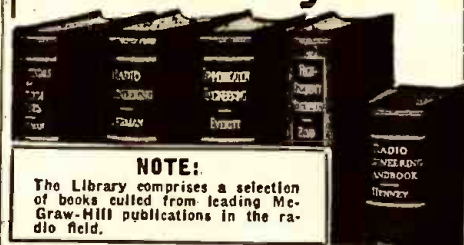

NOTE:

The Library comprises a selection of books culled from leading McGraw-Hill publications in the radio field.

- especially selected by radio specialists of McGraw-Hill publications
- to give most complete, dependable coverage of facts needed by all whose fields are grounded on radio fundamentals
- available at a special price and terms

THESE books cover circuit phenomena, tube theory, networks, measurements, and other subjects—give specialized treatments of all fields of practical design and application. They are books of recognized position in the literature—books you will refer to and be referred to often. If you are a practical designer, researcher or engineer in any field based on radio, you want these books for the help they give in hundreds of problems throughout the whole field of radio engineering.

5 VOLUMES, 3319 PAGES, 2289 ILLUSTRATIONS

1. Eastman's FUNDAMENTALS OF VACUUM TUBES
2. Terman's RADIO ENGINEERING
3. Everitt's COMMUNICATION ENGINEERING
4. Mundt's HIGH FREQUENCY MEASUREMENTS
5. Henney's RADIO ENGINEERING HANDBOOK

10 days' examination. Easy terms. Special price under this offer less than books bought separately. Add these standard works to your library now; pay small monthly installments, while you use the books.

10 DAYS' FREE EXAMINATION—SEND COUPON

McGraw-Hill Book Co., 330 W. 42nd St. New York 18

Send me Radio Engineering Library, 5 vols., for 10 days' examination on approval. In 10 days I will send \$3.00 plus few cents postage, and \$3.00 monthly till \$24.00 is paid, or return books postpaid. (We pay postage on orders accompanied by remittance of first installment.)

Name

Address

City and State

Position

Company RC 3-45

MATHEMATICS FOR RADIO

Two volumes, prepared for home study. Book I (314 pp.) covers the algebra, arithmetic, and geometry; Book II (329 pp.) covers the advanced algebra, trigonometry, and complex numbers necessary to read technical books and articles on radio.

MAEDEL PUBLISHING HOUSE Room 117
593 East 38 Street, Brooklyn, New York

Send me MATHEMATICS FOR RADIO AND COMMUNICATION as checked below. I enclose payment therefor with the understanding that I may return the book(s) within 5 days in good condition and my money will be refunded.

Name

Address

- Book I at \$3.75 plus 6c postage
- Book II at \$4.00 plus 6c postage
- Books I and II at \$7.75 postage prepaid

Foreign and Canadian prices 25c per volume higher

RADIO SCHOOL DIRECTORY

PREPARE NOW FOR POST-WAR RADIO AND ELECTRONICS

MAKE a place for yourself in a new world of radio and electronics—a world in which revolutionary electronic developments will require highly specialized technical knowledge. Take a good course now to fit yourself for a good paying job. The training you need can be supplied by one of the schools advertised in this publication.

RADIO ELECTRONICS

MRI

Intensive training in Airline, Merchant Marine, Press Communications, Electronics, Television, Co-educational. **FREE** booklet.

VETERANS:
Request **FREE** copy, G.I. bill of rights

"A Radio School managed by radio men."
45 W. 45th St., Dept. RC, New York 19, N.Y.

MELVILLE RADIO INSTITUTE

LES Correspondence Courses in **RADIO and ELECTRICAL ENGINEERING**

ELECTRICAL ENGINEERING Get good grasp of wide electrical field. Prepare yourself, at Low Cost, for secure future. Modern, simplified, you can understand quickly.

RADIO ENGINEERING Extra fine course in radio, publication, photo-electric work. Trains you to be super-service man, real vacuum tube technician. Servicemen needed badly. Diploma on completion. Tuition \$25, either course. Deferred payment plan.

FREE Get copies of school catalogs, student magazines, complete details. **SEND NOW!**

LINCOLN ENGINEERING SCHOOL Box 931C-73 Lincoln, Nebr.

CODE SENDING SPEED

Be a "key" man. Learn how to send and receive messages in code by telegraph and radio. Army, Navy and Commerce need thousands of men. Good pay, adventure, interesting work. Learn at home quickly through famous Candler System. Write for **FREE** BOOK.

CANDLER SYSTEM CO.
Dept. 3-C, Box 928, Denver 1, Colo., U. S. A.

RADIO

Courses Qualifying for Service Technician • Laboratory Technician (Electronic Television) Communications Operator

Register Now for New Classes Starting 1st Monday of each Month. Day and Evening Classes.

AMERICAN RADIO INSTITUTE
88 Columbus Avenue, New York 23, N. Y.

• • • **LOOK AT THE CAPITOL RADIO ENGINEERING INSTITUTE** • • •

MESSAGE ON PAGE 378

POLICE radio equipment took part in the rapid American advance across France, the War Department revealed last month.

Many times during the racing pursuit of the Nazis toward Germany, wire could not keep immediate pace with fast-moving armored columns, but the Signal Corps met the need by introducing a system of very high frequency (VHF) radio relay equipment.

This radio relay system consists of stations 25 to 100 miles apart, each beamed on the next like a rifle on a target. The military possibilities of this system were developed in America and England after it was first tried out in North Africa.

A considerable quantity of police scout car radio equipment had been procured for expected police communications requirements in North Africa, and this equipment was found admirably suited to provide communications for the rapid advance. As a result of this successful experiment and concurrent British groundwork, the amazing

RADIO-TELEVISION ELECTRONICS

offer ever-increasing post-war opportunities for trained men and women. R-T I courses prepare you by combining theory with practical laboratory experience.

Consideration given to Veterans eligible for training under the G. I. Bill.

Day & Evening Sessions. Apply daily 9-9. Sat. 9-2. Request Information.

Radio-Television Institute
480 Lexington Avenue, N. Y. 17 (46th St.)
PLaza 3-4585 Licensed by N. Y. State

RCA INSTITUTES

Offer thorough training courses in all technical phases of **Radio and Television**

DAYS—EVENINGS **WEEKLY RATES**

VETERANS: RCA Institutes is approved under G. I. Bill of Rights

For Free Catalog Write Dept. RC-45

RCA INSTITUTES, Inc.
A Radio Corporation of America Service
75 VARICK STREET NEW YORK 13, N. Y.

COMMERCIAL RADIO INSTITUTE

A radio training center for twenty-four years.

RESIDENT COURSES ONLY
Pre-Induction, Broadcast, Service, Aeronautical, Television and Marine telegraphy classes now forming. Literature upon request.

Home Study Course in Mathematics
Dept. C., 38 West Biddle St., Baltimore 1, Md.

Pre-Induction RADIO COURSES

for Civilians and those entering Military Services. Now classes now starting for men and women.

• RADIO OPERATING • CODE
• RADIO SERVICING — ELECTRONICS

New York Y.M.C.A. Schools
4 W. 64th Street New York City

★ **BUY AN** ★
★ **EXTRA WAR BOND** ★

radio relay link equipment in use today was developed and was made to provide four teleprinter circuits plus three radio telephone circuits as compared with one teleprinter circuit of the experimental models in Africa.

NEW RADIO STAMP

This airmail stamp was issued by Mexico to mark its third annual Book Fair. Most prominent among the means of disseminating knowledge shown is the microphone. A book and a movie camera are also shown, against the background of a newspaper.



"PAY OR SQUEAL" RADIOS

(Continued from page 337)

an endless stream of nauseating advertising plugs that certainly should be curbed. Worst offenders are the so-called "spots," the singing and whistling abominations which din rank advertising of questionable value constantly into our ears. Indeed, the better and larger stations now refuse entirely to broadcast this type of advertising. It is here where subscription radio can prove to be a most effective counter-irritant to the raw radio advertising that now clutters up our radio channels.

In this respect the "Pay or Squeal Radio" threat will prove its worth—indeed radio broadcasters are now viewing advertising-free radio with considerable concern, and with good reason.

It is of interest too that the Subscription Radio people themselves recently had a survey made by the Office of Radio Research of Columbia University. This survey polled 1,500 families with incomes of \$30.00 a week or more. 37 percent indicated that they would subscribe to such a new service, 58 percent would not subscribe under any circumstances and 5 percent did not quite know. It appears also that subscription radio, on such a basis, could make a go of it, even if only one family in eighty subscribed!

Faced with this formidable array of facts it is certain that advertising-free radio will force the old broadcasters to clean house—and clean house they must. Only in this case will present radio broadcasting survive.

There are other factors, also of interest. Suppose subscription radio gets on the air. If you are a radio man you may install your own filter or you can have it installed by a service man without benefit of the Subscription Radio Corporation. Do you break a law in doing so? This is doubtful, at least at present. *Radio-Craft* consulted a number of legal authorities who were emphatic that there is nothing in the present radio law that would make it unlawful for you to install your own filter, should you choose to do so. The point here is that you are not using energy, as if you tapped the gas or the electric mains; you cannot be sued and made to pay for using a radio service for your own private benefit.

It is conceivable that if the subscription service should win the favor of the entire country in years to come that a law could be passed making it unlawful to listen without paying for such radio service. That such a law will be passed seems, however, doubtful. On the other hand the Subscription Radio people go by averages and know quite well that most people in this country are honest and willing to pay for a service.

Moreover, the percentage of people who will bootleg filters into their radio sets is probably not large enough to worry the present sponsors of the proposal.

There are other doubts that begin to appear against subscription radio. The advent of television will assuredly change the entire aspect of radio advertising. It is well-known that the average individual never objects as much to the printed word, sign or billboard as he objects to the same advertisement when it is dimmed into his sensitive ears. If television can solve the advertising problem in a more subtle manner, without offending the public, it would seem that subscription radio will never get very far in this country.

At the present time the Pay or Squeal idea,—or rather the threat of it—to the broadcasting industry may be said to be a good thing. It certainly will be a powerful factor in shaping the future of American radio advertising.

TECHNOTES

(Continued from page 383)

.... SPARTON 6310

When distortion appears, make a resistance test at the 6Q7, second detector plate. If low or zero, replace the by-pass condenser here. Due to high resistance, a voltage check will not show up the trouble.

.... PHILCO 705P COMB.

The beam-of-light pilot requires a fine adjustment. This is the third from the left adjustment screw, facing back of chassis. It should be set for no more than sufficient light at normal speaker volume. Otherwise, the pilot may blow out, and also give rise to distortion.

G. P. ROGAL,
Montreal, Canada.

.... R.C.A. VICTOR MODELS 85BK AND BT

Trouble, lack of volume and fading.

These sets employ a 1F6 tube as second detector and A.V.C. The trouble appears after replacement of the original 1F6. Voltage and current readings are normal.

This is due to the fact that two distinct types of 1F6 tube were produced without any marks to distinguish them. The original 1F6 tube in these and also some Westinghouse Models had a metal cylinder in the left side of the envelope when you held the 1F6 mark towards you. This type was discontinued. The standard type will not work in the delayed A.V.C. system of the above mentioned sets.

Contrary to common practice these models were wired with the No. 1 diode grounded and No. 2 diode used for injection.

The best solution is to rewire the A.V.C. line to conform to the wiring used on the latter models, or any set of the same year that used the standard type tube.

The A.V.C. line is applied to the 1C6 grid through a 470,000-ohm resistor. This should be retained as the R.F. coils are single windings so the line cannot be coupled in the usual manner.

J. H. EASTMAN,
Moose Jaw, Canada.

(We are not sure that the facts are as stated above, but in any case the note is printed for what it may be worth.—Editor)

.... SPEAKER CONE REPAIRS

Speaker cones which have been torn loose at the edges can be repaired in the following manner. Cut a number of pieces of Scotch tape about an inch long and apply these straight from the edge of the speaker cone to the frame. If the cone is completely loose from the frame at the edges, at the start place four of the strips at equal distances around the cone to hold it in place. Centering shims should be in place and left in until the strips have been applied all around the cone. This method is more satisfactory than trying to cut a circular piece of paper. The adhesive on the tape does not seem to draw the cone out of shape as some cement does.

T. J. PITMAN,
Dewey, Oklahoma.

.... RCA No. 45 E.W.

A metal strip lining the inside of the wood cabinet greatly increases signal pick-up. This strip, in the plane of the loop, is attached to the antenna post.

GEORGE R. FLAKE,
Philadelphia, Pa.



MODEL 202

Meter cannot be damaged from over-voltage on any range due to the electronic circuit arrangement. Built with 4 tubes and pilot light. Power supply is self-contained. Operates on 110 to 120 volts, 50-60 cycles A.C., with voltage regulation included. Special range control switch, selector switch, ohms adjust control, zero balance control and a large 5" square meter with a 17" scale length. Size 10½" high, 7½" deep, and 8" wide. Weighs 14 lbs. and is finished in baked crackle lacquer. It's a honey for convenience and dependability.

THE HICKOK ELECTRICAL INSTRUMENT COMPANY

10531 Dupont Avenue, Cleveland 8, Ohio

THE STANDARD OF QUALITY FOR A THIRD OF A CENTURY

**NEW EDITION
NOW READY**

Audels RADIOMANS GUIDE

Includes **TELEVISION
AND ELECTRONICS**

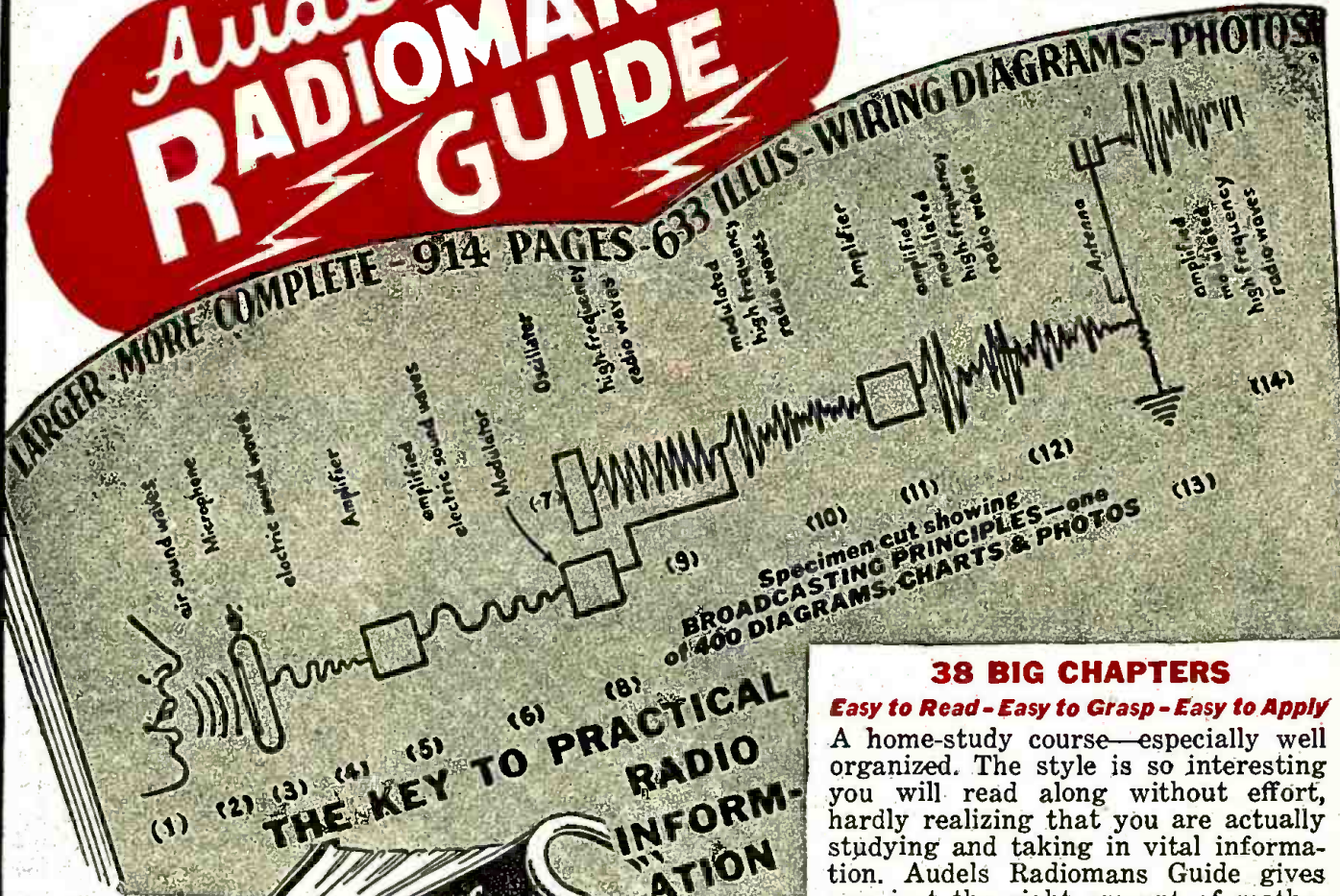

It gives you in usable form pointers on radio, including frequency modulation, television, etc. Also valuable inside information for Aviators, Marines, Commercial Operators and Technicians, Servicemen and Students.

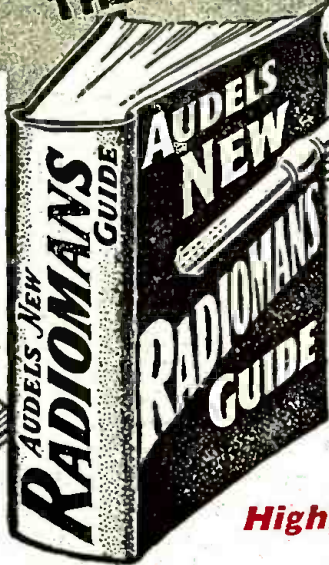

**Q AND A
UNIQUE
QUESTION
and
ANSWER
METHOD**

Highly Endorsed

38 BIG CHAPTERS
Easy to Read - Easy to Grasp - Easy to Apply
A home-study course—especially well organized. The style is so interesting you will read along without effort, hardly realizing that you are actually studying and taking in vital information. Audels Radiomans Guide gives you just the right amount of mathematics required to cope with radio problems successfully. You can solve, with the aid of this extraordinary book, practically every radioproblem that comes up. At your finger tips is a complete index for instant use.



1001 RADIO FACTS AND FIGURES
A Complete Library In One Book
AUDELS RADIOMANS GUIDE gives authentic Principles and Practices in Construction, Operation, Service and Repairs. Covers clearly and concisely radio fundamentals—Ohm's Law—Physics of sound as related to radio science—Measuring instruments—Power supply—Resistors—Inductors—Condensers—Transformers and examples—Broadcasting stations—Radio Telephony—Receivers—Diagrams—Construction—Control Systems—Loudspeakers—Antennas—AutoRadio—Phonograph Pick-ups—Public Address Systems—Aircraft and Marine Radio—Radio Compass—Beacons—Automatic Radio Alarms—Short Wave—Coil Calculations—Testing—Cathode Ray Oscillographs—Static Eliminations—Trouble Pointers—Underwriter's standards—Units and tables. REVIEW QUESTIONS—READY Reference Index.

7 DAYS' FREE TRIAL

THEO. AUDEL & CO., Publishers
49 West 23rd Street, New York 10, N. Y.

Mail AUDELS NEW RADIOMANS GUIDE for free examination. If O. K. I will send you \$1 in 7 days; then remit \$1 monthly until \$4 is paid. Otherwise I will return it.

Name _____
Address _____
Occupation _____
Reference _____

\$4 COMPLETE PAY ONLY \$1 A MO.

MAIL THIS COUPON TODAY

RCF

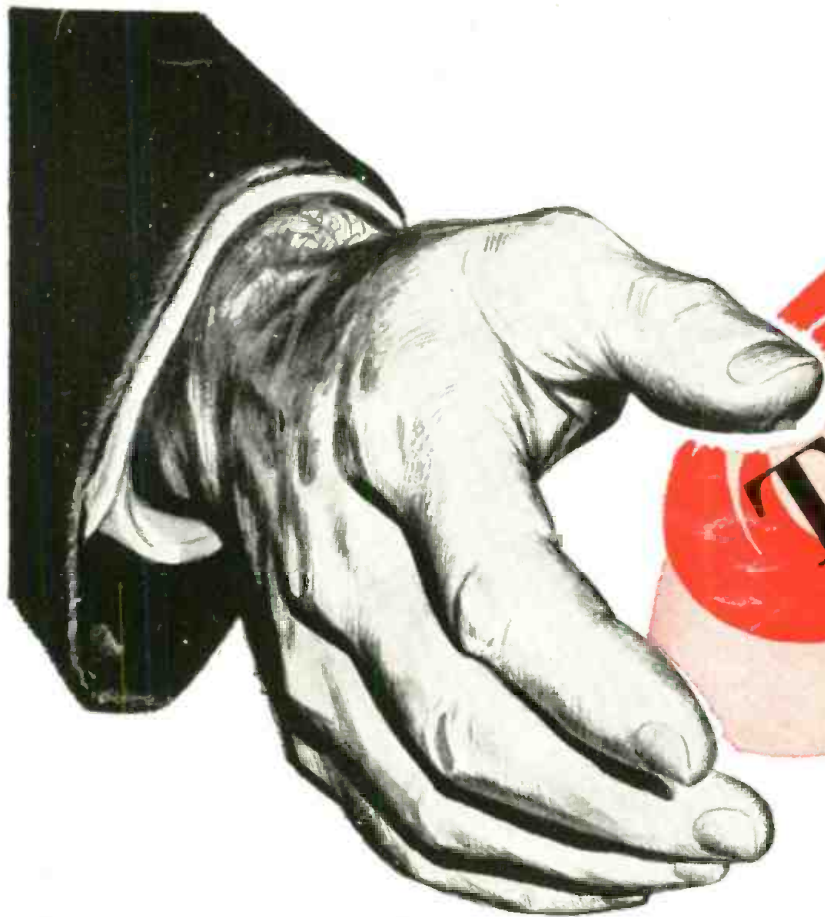

TO thousands of service engineers here in America, Mallory owes a debt of gratitude. For a long time now many of you have preferred to use Mallory Vibrators. But quite often during the past two years, our distributors have been unable to fill your orders.

Of course there has been good reason for this. With the outbreak of war, radio components for military use were needed in enormous quantities. Quality considerations too, were of the utmost importance.

Our vibrators were able to meet the most exacting tests. We were also the largest producers. As a result, our facilities were taxed to the utmost; we were unable to keep up with civilian demands.

We think you will be glad to know that today Mallory vibrators are in planes, tanks, portable radios and many other types of equipment on every fighting front. Not only are they serving American forces, but those of all our allies. These are the vibrators you did *without*.

Now, with production several hundred percent greater than in 1942, Mallory vibrators are again available for civilian use. Always noted for dependable performance, they are today even better *than ever*. So look for the familiar orange and blue carton on your distributor's shelves. You've had a long wait for Mallory vibrators—but the wait has been worth while!

P. R. MALLORY & CO., Inc., INDIANAPOLIS 6, INDIANA



Distribution of Mallory vibrators is being made as rapidly as possible. If your distributor has not yet received his supply, please bear with him.

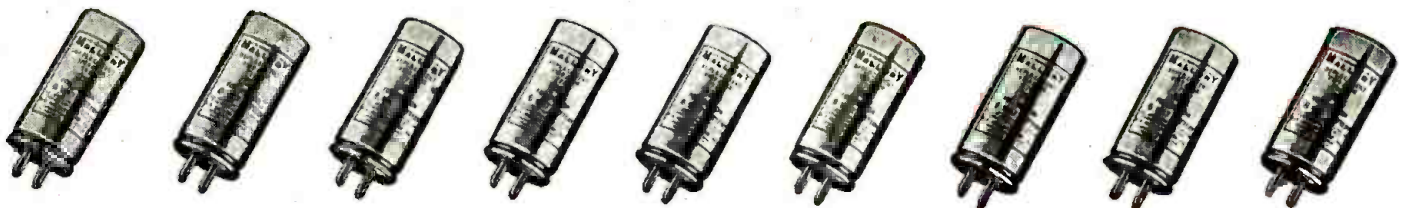

*More than ever—
ALWAYS
INSIST ON*

P. R. MALLORY & CO. Inc.
MALLORY
APPROVED
PRECISION PRODUCTS

**VIBRATORS • VIBRAPACKS* • CONDENSERS
VOLUME CONTROLS • SWITCHES • RESISTORS
FILTERS • RECTIFIERS • POWER SUPPLIES**

ALSO MALLORY "TROPICAL" DRY BATTERIES, ORIGINALLY DEVELOPED BY MALLORY FOR THE U. S. ARMY SIGNAL CORPS, NOT PRESENTLY AVAILABLE FOR CIVILIAN USE.

©Trademarks



Youth and Experience—That's one combination that enables Meissner "precision-el" to produce the quality electronic equipment for which Mt. Carmel is gaining national recognition, for skill in electronics is rapidly becoming a tradition in this little city on the banks of the Wabash.

"PRECISION-EL"

You'll find it
in Mt. Carmel, Illinois

Yes, here at Mt. Carmel, the men and women of Meissner bear the name of "precision-el" proudly. It is an honor and responsibility—an honor to be ranked with the most skilled craftsmen in an industry that is precision itself; a responsibility to uphold the Meissner standards of quality, accuracy and dependability.

On this page you will meet a few of the hundreds of men and women in Meissner's employ. Remember that they are your guarantee of performance when you use Meissner products, precision-built by "precision-el."



Light, Airy workrooms like this make any job pleasant. And when it's a precision job in electronics, like those jobs these men and women of Meissner are doing, no wonder they are able to merit the name "precision-el" for their pride in an exacting job well done.



No part is too small to merit the concentration and precision workmanship that characterizes Meissner precision-built products. Here a member of Meissner's "precision-el" shows why the name is so well deserved by the men and women of Meissner.



"Step Up" Old Receivers!

These Meissner Ferrocart I. F. input and output transformers are getting top results in stepping up performance of old worn receivers. Special powdered iron core permits higher "Q" with a resultant increase in selectivity and gain, now available for frequency range 127-206. Ask for numbers 16-5728 input, 16-5730 output, List \$2.20 each.



MEISSNER

MANUFACTURING COMPANY • MT. CARMEL, ILL.

ADVANCED ELECTRONIC RESEARCH AND MANUFACTURE

Export Division: 25 Warren St., New York; Cable: Simonrice